



# *Tripla65II*

**Ed. 12/2006**

**Codice 412162  
N° doc. 10005645**



## CATALOGO RICAMBI

### INTRODUZIONE

Il presente vuole essere da guida per l'ordinazione delle parti di ricambio ed è stato realizzato in modo da consentire una rapida identificazione della macchina in tutte le sue versioni e quindi una rapida visualizzazione dei pezzi che la compongono.

### MODALITA' DI ORDINAZIONE

Per facilitare la ricerca di magazzino e la spedizione dei pezzi di ricambio, si pregano vivamente i Sigg. Clienti di attenersi alle seguenti norme e specificare sempre :

- a) modello e numero di matricola della macchina;
- b) numero di posizione e numero di tavola dove sono rappresentati;
- c) codice di ordinazione e denominazione;
- d) quantità dei pezzi desiderati;
- e) indirizzo esatto e ragione sociale del Committente, completo con l'eventuale recapito per la consegna della merce;
- f) mezzo di spedizione desiderato. (Nel caso questa voce non sia specificata la Ditta Costruttrice si riserva di usare a sua discrezione il mezzo più opportuno).

## SPARE PARTS CATALOGUE

### INTRODUCTION

This catalogue is intended to serve as a guide for the ordering of spare parts and is designed to facilitate rapid identification of the machine in all its versions and to rapid location of its component parts.

### HOW TO ORDER

For the purpose of simplifying stock searching and the delivery of spare parts, we would ask our customers to observe the following standard procedures, at all times specifying:

- a) the model and part number of the machine;
- b) the position number and the number of the table of chart in which the parts appear;
- c) ordering code and part name;
- d) quantity of parts required;
- e) precise address and company status of the purchaser placing the order, complete with address for delivery of the goods;
- f) shipping means required.

## CATALOGUE DES PIECES DE RECHANGE

### INTRODUCTION

Le présent catalogue a pour but de guider l'utilisateur dans les commandes de pièces détachées. Il a été réalisé pour faciliter une identification rapide de la machine dans toutes ses versions et permet ainsi un repérage rapide de ses composants.

### COMMENT PASSER COMMANDE

Afin de simplifier la recherche dans le magasin et l'expédition des pièces de rechange, nous prions notre clientèle de respecter la procédure suivante en indiquant toujours:

- a) le modèle et numéro de la machine;
- b) le numéro de la position et numéro du tableau sur lequel figure la pièce;
- c) la référence et la dénomination;
- d) la quantité des pièces demandées;
- e) l'adresse exacte et la raison sociale de l'acheteur qui passe la commande, en indiquant l'adresse de livraison;
- f) le moyen de transport désiré (dans le cas où ceci n'est pas précisé l'expéditeur se réserve le droit de choisir le transporteur).

## ERSATZTEILKATALOG

### EINLEITUNG

Der vorliegende Katalog versteht sich als Führer für Ersatzteile und soll eine rasche Identifikation der Maschine in all ihren Ausführungen ermöglichen und daher ein sofortiges Erkennen der Teile, aus denen sie besteht.

### BESTELLVORSCHLAG

Um ein Auffinden im Lager und den Versand der Ersatzteile zu erleichtern, werden die Kunden ersucht, sich an folgende Normen zu halten und immer folgendes anzugeben:

- a) Modell- und Gerätenummer;
- b) Positions- und Tafelnummer, wo sie dargestellt sind;
- c) Bestellnummer und Handelsbezeichnung;
- d) Menge der gewünschten Teile;
- e) Genaue Adresse und Firmennamen des Auftraggebers, gemeinsam der ev. Anschrift für die Zusendung der Ware;
- f) Die gewünschte Versandart (falls nicht angegeben, behält sich der Lieferant das Recht vor, die günstigste Art zu wählen).

## CATALOGO PIEZAS DE REPUESTO

### INTRODUCCIÓN

Ese catálogo quiere servir cómo guía para pedir las piezas de repuesto y se ha realizado de manera de consentir una rápida identificación de la máquina en todas sus versiones y por consiguiente una rápida individuación de las piezas que la componen.

### MODALIDADES DE LOS PEDIDOS

Para la búsqueda en el almacén y el envío de las piezas de repuesto, se ruega encarecidamente a los Sres. Clientes de seguir las reglas siguientes y de especificar siempre:

- a) el modelo y el número de matrícula de la máquina;
- b) el número de posición y el número de la tabla donde son representadas;
- c) el código de pedido y la denominación;
- d) el número de piezas que se desean;
- e) las señas exactas y la razón social del Comitente, indicando también las señas eventuales para la entrega de la mercancía;
- f) El medio de envío que se desea. (En caso de que ese dato no se haya especificado, la Empresa Constructora se reserva el derecho de utilizar a su elección el medio más adecuado.

### SIMBOLOGIA USATA NEL CATALOGO

SYMBOLGY USED IN THE CATALOGUE

SIMBOLE DANS LE CATALOGUE

SIMBOLGEBRAUCH IM KATALOG

SIMBOLOGIA EMPLEADA EN EL CATALOGO

→ I XXXXXXXX

Codice utilizzato fino alla matricola indicata  
Code used up to the indicated serial number  
Code utilisé jusqu'au numéro indiqué  
Artikel benutzt bis zur angegebenen Nummer  
Código utilizado hasta el número indicado

XXXXXXX I →

Codice utilizzato dalla matricola indicata  
Code used from the indicated serial number  
Code utilisé a partir du numéro indiqué  
Artikel benutzt ab angegebenen Nummer  
Código utilizado desde el número indicado



---

## SOMMARIO

### SUMMARY / SOMMAIRE / INHALTSANGABE / ÍNDICE

- TAV. 01A GRUPPO BASAMENTO LAVANTE**  
BRUSHES BASE ASSY WITH SCRUBBING SYSTEM / GROUPE PLATEAU DES BROSSES AVEC SYSTEME DES BROSSES ROTATIVES / GRUPPE BÜRSTENGESTELL MIT TELLERBÜRSTENVORRICHTUNG / GRUPO BANCADA CEPILLOS CON SISTEMA CEPILLOS GIRATORIOS
- TAV. 01B GRUPPO BASAMENTO SPAZZANTE**  
BRUSHES BASE ASSY WITH SWEEPING SYSTEM / GROUPE PLATEAU DES BROSSES AVEC SYSTEME BALAYEUSE / GRUPPE BÜRSTENGESTELL MIT WALZENVORRICHTUNG / GRUPO BANCADA CEPILLOS CON SISTEMA CEPILLOS CILINDRICOS
- TAV. 02 GRUPPO RIDUTTORI**  
REDUCTION GEARS ASSEMBLY / GROUPE DE REDUCTEURS / GETRIEBEGRUPPE / GRUPO REDUCTORES
- TAV. 03 GRUPPO COMANDO SPAZZOLE**  
BRUSHES CONTROL ASSEMBLY / GROUPE COMMANDE DES BROSSES / GRUPPE BÜRSTENBETÄTIGUNG / GRUPO MANDO CEPILLOS
- TAV. 04 GRUPPO STERZO**  
STEERING GEAR / ENSEMBLE DE VOLANT / LENKGRUPPE / GRUPO DE DIRECCIÓN
- TAV. 05 GRUPPO TRAZIONE**  
TRACTION ASSEMBLY / ENSEMBLE TRACTION / ANTRIEBSGRUPPE / GRUPO TRACCIÓN
- TAV. 06 GRUPPO FRENO E RUOTE**  
BRAKE AND WHEELS ASSEMBLY / GROUPE DE FREIN ET ROUES / BREMSANLAGE - HINTERRÄDER / GRUPO FRENO Y RUEDAS
- TAV. 07 GRUPPO SERBATOIO SOLUZIONE**  
SOLUTION TANK ASSEMBLY / GROUPE DE RESERVOIRS EAU PROPRE / GRUPPE FRISCHWASSERTANK / GRUPO TANQUES SOLUCI ÓN
- TAV. 08 GRUPPO SERBATOIO RECUPERO**  
RECOVERY TANK ASSEMBLY / GROUPE DE RESERVOIRS RECUPERATION / GRUPPE SCHMUTZWASSERTANK / GRUPO TANQUES RECUPERACIÓN
- TAV. 08A GRUPPO SERBATOIO RECUPERO**  
RECOVERY TANK ASSEMBLY / GROUPE DE RESERVOIRS RECUPERATION / GRUPPE SCHMUTZWASSERTANK / GRUPO TANQUES RECUPERACIÓN
- TAV. 09A GRUPPO TERGIPAVIMENTO (LAVANTE)**  
SQUEEGEE ASSEMBLY / ENSEMBLE DE SUCEUR / SAUGFUSSGRUPPE / GRUPO LIMPIAPAVIMENTOS
- TAV. 09B GRUPPO TERGIPAVIMENTO (SPAZZANTE)**  
SQUEEGEE ASSEMBLY / ENSEMBLE DE SUCEUR / SAUGFUSSGRUPPE / GRUPO LIMPIAPAVIMENTOS
- TAV. 10 GRUPPO COMANDO TERGIPAVIMENTO**  
SQUEEGEE CONTROL ASSEMBLY / GROUPE COMMANDE DE SUCEUR / GRUPPE SAUGFUSSBETÄTIGUNG / GRUPO MANDO LIMPIAPAVIMENTOS
- TAV. 11 GRUPPO TELAIO CARROZZERIA**  
ASSEMBLY FRAME-BODYWORK / GROUPE DE CHASSIS-CARROSERIE / GRUPPE FAHRGESTELL-KAROSSERIE / GRUPO BASTIDOR-CARROCERIA
- TAV. 11A GRUPPO TELAIO CARROZZERIA**  
ASSEMBLY FRAME-BODYWORK / GROUPE DE CHASSIS-CARROSERIE / GRUPPE FAHRGESTELL-KAROSSERIE / GRUPO BASTIDOR-CARROCERIA
- TAV. 12 COMPONENTI ELETTRICI**  
ELECTRIC COMPONENTS / COMPOSANTS ELECTRIQUES / ELEKTROTEILE / COMPONENTES ELÉCTRICOS
- TAV. 13 ACCESSORI**  
ACCESSORIES / ACCESSOIRES / ZUBEHÖRTEILE / ACCESORIOS
-

01A

GRUPPO BASAMENTO LAVANTE  
BRUSHES BASE ASSY WITH SCRUBBING SYSTEM  
GROUPE PLATEAU DES BRUSSES AVEC SYSTEME DE BRUSSES ROTATIVES  
GRUPPE BUERSTENGESTELL MIT TELLERBUERSTENVORRICHTUNG  
GRUPO BANCADA CEPILLOS CON SISTEMA CEPILLOS GIRATORIOS

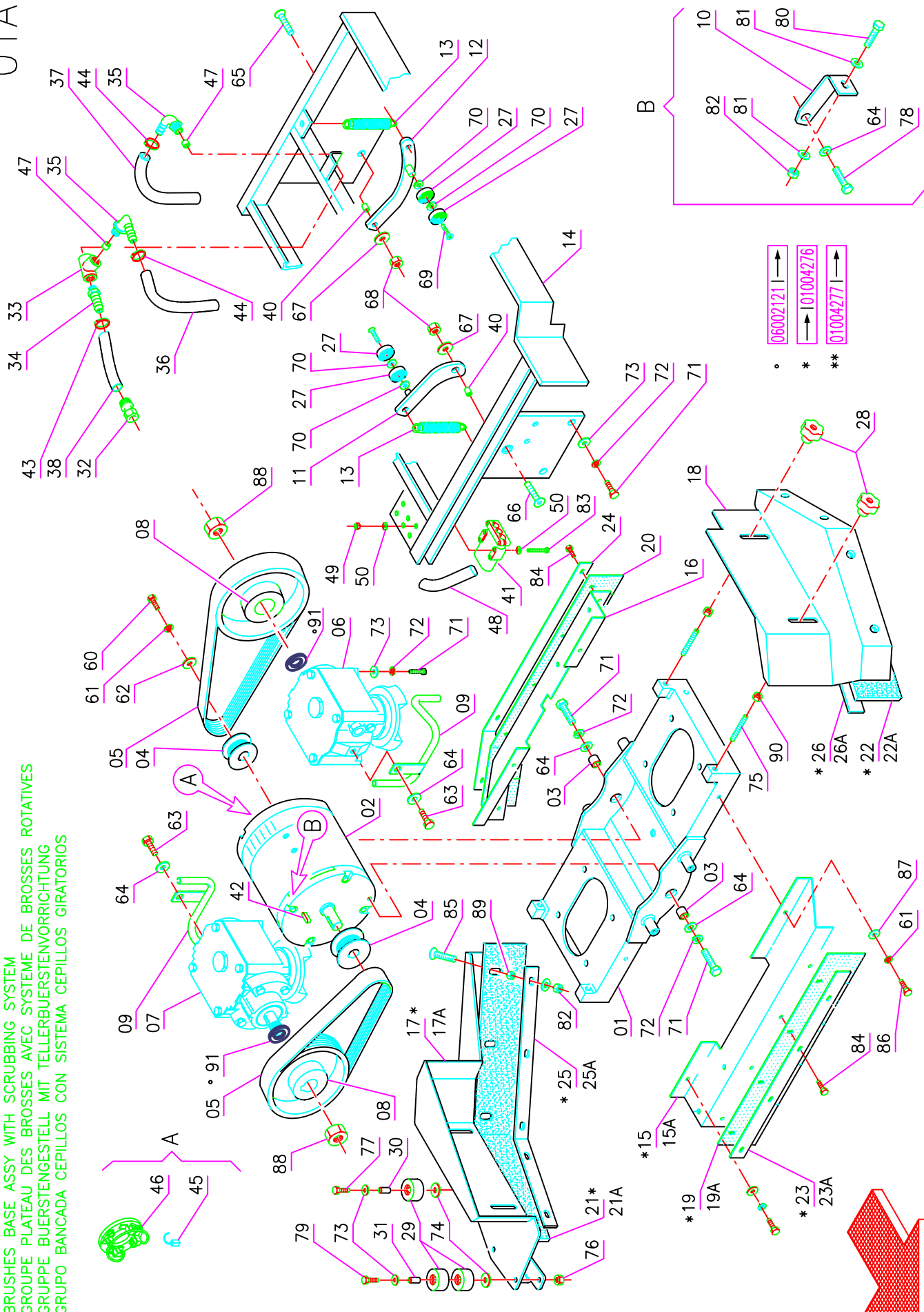

Pos. Mod.	Codice	Q.tà	Denominazione	Description	Description	Benennung	Description
01	408285	1	BASAMENTO SPAZZOLE	BRUSHES BASE	EMBASE DES BROSSES	BÜRSTENGESTELL	BANCADA CEPILLOS
02	407739	1	MOTORE 36V-900W	MOTOR	MOTEUR	MOTOR	MOTOR
03	408041	2	BOCCOLA	BUSHING	BAGUE	BUCHSE	CASQUILLO
04	210268	2	PULEGGIA MOTORE	PULLLEY	POULIE	RIEMENSCHLEIBE	PULEA
05	408325	2	CINGHIA POLY V J8-584	BELT	COURROIE	RIEMEN	CORREA
06	210506	1	ASSEMBLE RIDUTTORE SX	REDUCTION GEAR ASSY, LEFT	REDUCTEUR COMPL. GAUCHE	GETRIEBE KOMPL. LINKS	GRUPO REDUCTOR IZQUIERDO
07	210682	1	ASSEMBLE RIDUTTORE DX	REDUCTION GEAR ASSY, RIGHT	REDUCTEUR COMPL. DROITE	GETRIEBE KOMPL. RECHTS	GRUPO REDUCTOR DERECHO
08	210270	2	PULEGGIA CONDOTTA	PULLLEY	POULIE	RIEMENSCHLEIBE	POLEA
09	203613	2	TUBO	PIPE	TUBE	ROHR	TUBO
10	203616	1	STAFFA	SUPPORT	ATTAQUE	HALTERUNG	SOPORTE FIJADOR
11	203614	1	TENDICINGHIA	TIGHTENER	TENDEUR	SPANNER	TENDEDOR
12	203615	1	TENDICINGHIA	TIGHTENER	TENDEUR	SPANNER	TENDEDOR
13	202475	2	MOLLA	SPRING	RESSORT	FEDER	RESORTE
14	203618	1	ATTACCO BASAMENTO	COUPLING	ATTAQUE	KUPPLUNG	ACOPLAMIENTO
15	400746	1	SUPPORTO PARASPRUZZI ANT.	SUPPORT	SUPPORT	HALTERUNG	SOPORTE
16	206544	1	SUPPORTO PARASPRUZZI	SUPPORT	SUPPORT	HALTERUNG	SOPORTE
17	400745	1	SUPPORTO PARASP. POST.	SUPPORT	SUPPORT	HALTERUNG	SOPORTE
18	206545	1	SUPPORTO PARASP. DX	SUPPORT	SUPPORT	HALTERUNG	SOPORTE
19	400747	1	SUPPORTO PARASP. SX	SUPPORT	SUPPORT	HALTERUNG	SOPORTE
20	206546	1	SUPPORTO PARASP. SX	SUPPORT	SUPPORT	HALTERUNG	SOPORTE
21	400748	1	SUPPORTO PARASPRUZZI SX	SUPPORT	SUPPORT	HALTERUNG	SOPORTE
22	406036	1	PARASPRUZZI ANT. L=416	SPLASH GUARD	BAVETTE DE PROTECTION	SPRITZGUMMI	PARASALPICADURAS
23	406042	1	PARASPRUZZI ANT. L=740	SPLASH GUARD	BAVETTE DE PROTECTION	SPRITZGUMMI	PARASALPICADURAS
24	406038	1	SUPPORTO PARASP. POST	SUPPORT	SUPPORT	HALTERUNG	SOPORTE
25	406037	1	PARASPRUZZI DX L=646	SPLASH GUARD	BAVETTE DE PROTECTION	SPRITZGUMMI	PARASALPICADURAS
26	406043	1	PARASPRUZZI DX L=573	SPLASH GUARD	BAVETTE DE PROTECTION	SPRITZGUMMI	PARASALPICADURAS
27	406039	1	PARASPRUZZI SX L=519	SPLASH GUARD	BAVETTE DE PROTECTION	SPRITZGUMMI	PARASALPICADURAS
28	406044	1	PARASPRUZZI SX L=454	SPLASH GUARD	BAVETTE DE PROTECTION	SPRITZGUMMI	PARASALPICADURAS
29	202365	1	LAMA PREMIGOMMA ANT.	BLADE	PLAQUETTE	LEISTE	LISTON
30	210039	1	LAMA PREMIGOMMA ANT.	BLADE	PLAQUETTE	LEISTE	LISTON
31	202367	1	LAMA PARASP. POST	BLADE	PLAQUE	PLATTE	LISTON
32	210040	1	LAMA PREMIGOMMA DX	BLADE	PLAQUE	PLATTE	LISTON
33	202368	1	LAMA PARASP. SX	BLADE	PLAQUETTE	LEISTE	LISTON
34	210041	1	LAMA PREMIGOMMA SX	BLADE	PLAQUE	PLATTE	LISTON
35	408427	4	CUSCINETTO SF.6202-2RS	BEARING	ROULEMENT	LAGER	COJINETE
36	410234	4	POMELLO VB40 M8	KNOB	POMMEAU	RENDELSCHRAUBE	POMO
37	405707	4	RUOTA PARACOLPI	WHEEL	ROUE	RAD	RUEDA
38	408033	2	BOCCOLA	BUSHING	BAGUE	BUCHSE	CASQUILLO
39	408021	2	BOCCOLA	BUSHING	BAGUE	BUCHSE	CASQUILLO
40	410435	1	RACCORDO RAPIDO 1/2	PIPE	RACCORD	STUTZEN	RACOR
41	410366	1	RACCORDO A T DA 1/2 G. F.	T-FITTING	RACCORD A T	T-VERSCHRAUBUNG	CODO DE TRES BOCAS
42	205020	1	PORTAGOMMA 1/2" D.16	CONNECTOR	RACCORD	SCHLAUCHANSCHLUSS	EMPALME TUBO DE GOMA
43	410350	2	PORTAGOMMA 1/2M. D.13	CONNECTOR	RACCORD	SCHLAUCHANSCHLUSS	EMPALME TUBO DE GOMA
44	202228	1	TUBO	PIPE	TUBE	ROHR	TUBO
45	202215	1	TUBO	PIPE	TUBE	ROHR	TUBO
46	209563	1	TUBO DI GOMMA	HOSE	TUYAU	SCHLAUCH	TUBO DE GOMA
47	408037	2	BOCCOLA	BUSHING	BAGUE	BUCHSE	CASQUILLO
48	409668	1	CONNETTORE MASCHIO 80A	CONNECTOR MALE	CONNECTEUR MALE	STECKER MIT ZAPFEN	CONECTOR MACHO
49	408402	2	CHIAVETTA 5x5x20 UNI 6604/69	KEY	CLAVETTE	KEIL	CLAVIJA
50	410297	1	FASCETTA A VITE	CLAMP	COLLIER	BRIDE	ABRAZADERA
51	410274	2	FASCETTA PLASTICA	CLAMP	COLLIER	BRIDE	ABRAZADERA
52	409420	4	SPAZZOLA MOTORE	CARBON BRUSH MOTOR	CHARBON MOTEUR	KOHLEBÜRSTE	ESCOBILLA MOTOR
53	409712	1	PORTASPAZZOLE COMPLETO	CARBON BRUSH HOLDER ASSY	PORTE-CHARBON COMPLET	KOHLEHALTERUNG KOMPLETT	PORTAESCOBILLAS COMPLETO
54	210111	2	DISTANZIALE	SPACER	ENTRETOISE	DISTANZHÜLSE	DISTANCIADOR
55	209371	1	GUAINA	SHEATH	GAINÉ	SCHUTZMANTEL	VAINA

01A

GRUPPO BASAMENTO LAVANTE  
 BRUSHES BASE ASSY WITH SCRUBBING SYSTEM  
 GROUPE PLATEAU DES BRUSSES AVEC SYSTEME DE BRUSSES ROTATIVES  
 GRUPPE BUERSTENGESTELL MIT TELLERBUERSTENVORRICHTUNG  
 GRUPO BANCADA CEPILLOS CON SISTEMA CEPILLOS GIRATORIOS

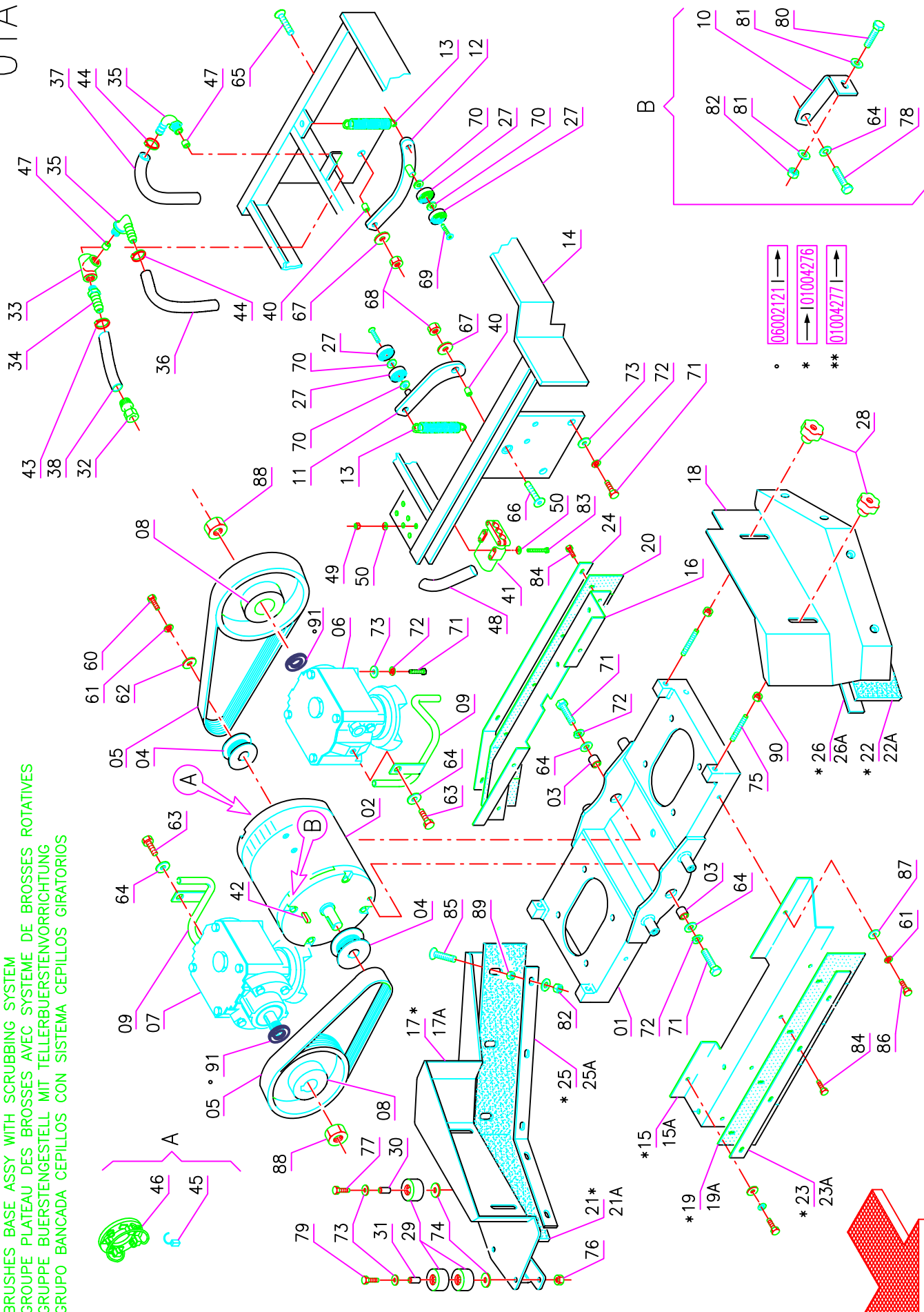

- 06002121 | →
- \* 101004276 | →
- \*\* 01004277 | →

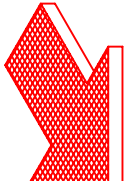

Pos. Mod.	Codice	Q.tà	Denominazione	Description	Description	Benennung	Description
60	407663		VITE M6X16 TE UNI 5739	SCREW	VIS	SCHRAUBE	TORNILLO
61	409164		RONDELLA GROWER Ø6	LOCK WASHER	RONDELLE FREIN	ZAHNSCHLEIBE	ARANDELA DENTADA
62	409162		RONDELLA Ø6x24 UNI 6593	WASHER	RONDELLE	UNTERLAGSCHEIBE	ARANDELA
63	408707		VITE M10x12 TE UNI 5739	SCREW	VIS	SCHRAUBE	TORNILLO
64	409191		RONDELLA Ø10x21 UNI 6592	WASHER	RONDELLE	UNTERLAGSCHEIBE	ARANDELA
65	408714		VITE M10x35 TE UNI 5739	SCREW	VIS	SCHRAUBE	TORNILLO
66	409001		VITE M10x40 TPSEI UNI 5933	SCREW	VIS	SCHRAUBE	TORNILLO
67	409194		RONDELLA Ø10x30 UNI 6593	WASHER	RONDELLE	UNTERLAGSCHEIBE	ARANDELA
68	409090		DADO AUTOBL. M10 UNI 7474	LOCK NUT	ECROU AUTOBLOQUANT	STOPMUTTER	TUERCA AUTOBLOCCANTE
69	408988		VITE M8X18 TPSEI UNI5933	SCREW	VIS	SCHRAUBE	TORNILLO
70	409213		RONDELLA Ø15x28 OTTONE	WASHER	RONDELLE	UNTERLAGSCHEIBE	ARANDELA LATON
71	408674		VITE M8x25 TE UNI 5739	SCREW	VIS	SCHRAUBE	TORNILLO
72	409181		RONDELLA Ø8 GROWER	WASHER	RONDELLE	UNTERLAGSCHEIBE	ARANDELA
73	409175		RONDELLA Ø8x17 UNI 6592	WASHER	RONDELLE	UNTERLAGSCHEIBE	ARANDELA
74	409179		RONDELLA Ø9x24 UNI 6593	WASHER	RONDELLE	UNTERLAGSCHEIBE	ARANDELA
75	408915		GRANO M8X35 E.I. UNI 5923	DOWEL	VIS CYLINDRIQUE	MADENSCHRAUBE	TORNILLO
76	409085		DADO AUTOBL. M8 UNI 7474	LOCK NUT	ECROU AUTOBLOQUANT	STOPMUTTER	TUERCA AUTOBLOCCANTE
77	408676		VITE M8x30 TE UNI 5739	SCREW	VIS	SCHRAUBE	TORNILLO
78	408709		VITE M10x20 TE UNI 5739	SCREW	VIS	SCHRAUBE	TORNILLO
79	408694		VITE M8X70 TE UNI5739	SCREW	VIS	SCHRAUBE	TORNILLO
80	407666		VITE M6x20 TE UNI 5739	SCREW	VIS	SCHRAUBE	TORNILLO
81	409156		RONDELLA Ø6x12 UNI 6592	WASHER	RONDELLE	UNTERLAGSCHEIBE	ARANDELA
82	409082		DADO M6 AUTOBL. UNI 7474	LOCK NUT	ECROU AUTOBLOQUANT	STOPMUTTER	TUERCA AUTOBLOCCANTE
83	408766		VITE M3X16 TC UNI 6107 INOX	SCREW	VIS	SCHRAUBE	TORNILLO
84	407646		VITE M5x16 TE INOX UNI 5739	SCREW	VIS	SCHRAUBE	TORNILLO
85	408972		VITE M6x25 TPSEI UNI 5933 INOX	SCREW	VIS	SCHRAUBE	TORNILLO
86	407658		VITE M6x10 TE UNI 5739 INOX	SCREW	VIS	SCHRAUBE	TORNILLO
87	409161		RONDELLA Ø 6x18 INOX UNI 6593	WASHER	RONDELLE	UNTERLAGSCHEIBE	ARANDELA
88	409097		DADO M16x1.5 AUT. UNI 7474	LOCK NUT	ECROU AUTOBLOQUANT	STOPMUTTER	TUERCA AUTOBLOCCANTE
89	409041		DADO M6 INOX UNI 5587	NUT	ECROU	MUTTER	TUERCA
90	409052		DADO M8 UNI 5587	NUT	ECROU	MUTTER	TUERCA
91	200967		DISTANZIALE	SPACER	ENTRETOISE	DISTANZHÜLSE	DISTANCIADOR

GRUPPO BASAMENTO SPAZZANTE  
 BRUSHES BASE ASSY WITH SWEEPING SYSTEM  
 GROUPE PLATEAU DES BROSSES AVEC SYSTEME BALAYEUSE  
 GRUPPE BUERSTENGESTELL MIT WALZENANVORRICHTUNG  
 GRUPO BANCADA CEPILLOS CON SISTEMA CEPILLOS CILINDRICOS

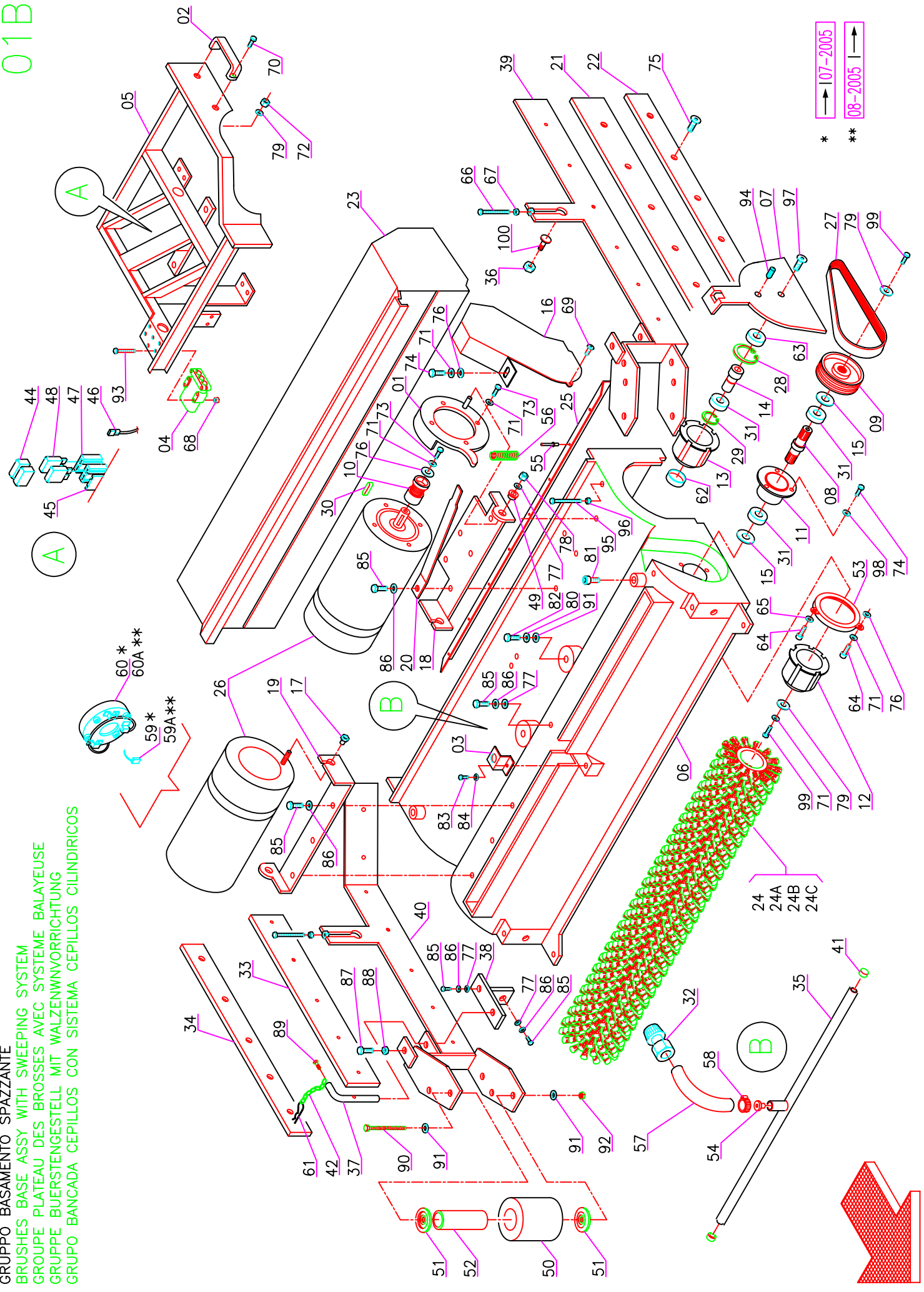



Pos. Mod.	Codice	Q.tà	Denominazione	Description	Description	Benennung	Description
01	203665	2	PIASTRA FISSAGGIO MOTORE	PLAQUE	PLAQUE	BEFESTIGUNGSAUFLAGE	PLACA
02	410272	1	MANIGLIA	HANDLE	MANCHE	HANDGRIFF	MANILLA
03	400364	1	STAFFETTA	SUPPORT	ATTAQUE	HALTERUNG	SOPORTE FIJADOR
04	409667	1	CONNETTORE F 80A	CONNECTOR FEMALE	CONNECTEUR FEMELLE	STECKER OHNE ZAPFEN	CONECTOR HEMBRA
04A	204355	1	CONNETTORE F 50A	CONNECTOR	CONNECTEUR	LADESTECKER	CONECTOR
05	203674	1	ATTACCO BASAMENTO	COUPLING	ATTAQUE	KUPPLUNG	ACOPLAMIENTO
06	200078	1	TUNNEL SPAZZANTE	TUNNEL	CARTER BALAI	TUNNEL	TUNEL
07	400115	2	PIASTRA MOBILE	PLAQUE	PLAQUE	BEFESTIGUNGSAUFLAGE	PLACA
08	400116	2	ALBERO COMANDO SPAZZOLE	SHAFT	ARBRE	WELLE	EJE
09	408153	2	PULEGGIA CONDOTTA	PULLEY	POULIE	RIEMENSCHLEIBE	POLEA
10	408154	2	PULEGGIA MOTRICE	PULLEY	POULIE	RIEMENSCHLEIBE	POLEA
11	200079	2	SUPPORTO FLANGIATO	SUPPORT	SUPPORT	HALTERUNG	SOPORTE
12	400117	2	MOZZO COMANDO SPAZZOLE	HUB	MOYEU	NABE	CUBO
13	200080	2	MOZZO FOLLE	FRONT BRUSH HUB	MOYEU BROUSSE AVANT	NABE VORDERE WALZE	CUBO CEPILLO DELANTERO
14	203667	2	PERNO PER MOZZO FOLLE	PIN	AXE	BOLZEN	PERNO
15	400118	4	RONDELLA SPECIALE	SPECIAL WASHER	RONDELLE SPECIALE	UNTERLAGSCHEIBE SPEZIAL	AFANDELA ESPECIAL
16	206621	2	CARTER CINGHIA	COVER	CARTER	ABDECKUNG	CARTER
17	408023	2	BOCCOLA	BUSHING	BAGUE	BUCHSE	CASQUILLO
18	203668	1	SUPPORTO SN MOTORE	LEFT SUPPORT MOTOR	SUPPORT GAUCHE MOTEUR	HALTERUNG LINKS MOTOR	SOPORTE IZQUIERDO MOTOR
19	203669	1	SUPPORTO DX MOTORE	RIGHT SUPPORT MOTOR	SUPPORT DROITE MOTEUR	HALTERUNG RECHTS MOTOR	SOPORTE DERECHO MOTOR
20	203670	2	MOLLA	SPRING	RESSORT	FEDER	RESORTE
21	406040	1	GOMMA PARASPRUZZI SN	RUBBER	BAVETTE	GUMMI	GOMA
22	202373	1	LAMA PREMIGOMMA SN	LEFT BLADE	PLAQUETTE GAUCHE	LINKE LEISTE	LISTON IZQUIERDO
23	400114	1	CASSETTO RACCOLTA	HOPPER	BAC A DECHETS	SCHMUTZBEHALTER	CAJON DE RECOLECCION
24	405597	2	SPAZZOLA CILINDRICA Ø150 PPL 0.7	CYLINDRICAL BRUSH	BROSSE CYLINDRIQUE	ZENTRALWALZE	CEPILLO CILINDRICO
24A	405598	2	SPAZZOLA CILINDRICA Ø150 PPL 1	CYLINDRICAL BRUSH	BROSSE CYLINDRIQUE	ZENTRALWALZE	CEPILLO CILINDRICO
24B	405599	2	SPAZZ. CIL. Ø150 PPL 0.8 GIALLA	CYLINDRICAL BRUSH	BROSSE CYLINDRIQUE	ZENTRALWALZE	CEPILLO CILINDRICO
24C	405600	2	SPAZZ. CIL. Ø150 TYNEX 1	CYLINDRICAL BRUSH	BROSSE CYLINDRIQUE	ZENTRALWALZE	CEPILLO CILINDRICO
25	400363	1	LAMA	BLADE	PLAQUE	PLATTE	LISTON
26	407743	2	MOTORE 36V 600W	MOTOR	MOTEUR	MOTOR	MOTOR
27	408323	2	CINGHIA PV J8	BELT	COURROIE	RIEMEN	CORREA
28	408341	2	SEEGER I35	SEEGER RING	SERRE CLIPS	SEEGERRING	ANILLO SEEGER
29	408353	2	SEEGER E 15	SEEGER RING	SERRE CLIPS	SEEGERRING	ANILLO SEEGER
30	408402	2	CHIAVETTA 5x5x20 UNI 6604/69	KEY	CLAVETTE	KEIL	CLAVIJA
31	408427	6	CUSCINETTO SF 6202-2RS	BEARING	ROULEMENT	LAGER	COJINETE
32	410435	1	RACCORDO RAPIDO 1/4	PIPE	RACCORD	STUTZEN	RACOR
33	406041	1	GOMMA PARASPRUZZI DX	RUBBER	BAVETTE	GUMMI	GOMA
34	202374	1	LAMA PREMIGOMMA DX	RIGHT BLADE	PLAQUETTE DROITE	RECHTE LEISTE	LISTON DERECHO
35	400757	1	TUBO DISTRIBUZIONE	PIPE	TUBE	ROHR	TUBO
36	203671	2	DISTANZIALE	SPACER	ENTRETOISE	DISTANZHUELSE	DISTANCIADOR
37	203672	2	PERNO LATERALE	PIN	AXE	BOLZEN	PERNO
38	203673	2	ATTACCO ANTERIORE	COUPLING	ATTAQUE	KUPPLUNG	ACOPLAMIENTO
39	400759	1	SUPPORTO PARASPRUZZI SX	LEFT SUPPORT	SUPPORT GAUCHE	HALTERUNG LINKS	SOPORTE IZQUIERDO
40	400758	1	SUPPORTO PARASPRUZZI DX	RIGHT SUPPORT	SUPPORT DROITE	RECHTE HALTERUNG	SOPORTE DERECHO
41	409832	2	TAPPO	COVER	COUVERCLE	DECKEL	TAPA
42	204895	2	CATENELLA	CHAIN	CHAINE	KETTE	CADENA
44	409871	2	COPERCHIO	COVER	COUVERCLE	DECKEL	TAPA
45	409872	1	PIASTRINA	PLAQUE	PLAQUETTE	BEFESTIGUNGSAUFLAGE	PLAQUETA
46	209381	2	CAVO NERO	CABLE	CABLE	KABEL	CABLE
47	409586	2	PORTAFUSIBILE 30A	FUSEHOLDER	PORTE-FUSIBLE	SICHERUNGSHALTER	PORTAFUSIBLE
48	409610	2	MAXIFUSIBILE	MAXIFUSE	MAXIFUSIBLE	MAXISICHERUNG	MAXIFUSIBLE
49	408061	2	BOCCOLA	BUSHING	BAGUE	BUCHSE	CASQUILLO
50	405711	4	RUOTA PARACOLPI Ø 80	WHEEL	ROUE	RAD	RUEDA
51	203352	8	RONDELLA SPECIALE	SPECIAL WASHER	RONDELLE SPECIALE	UNTERLAGSCHEIBE SPEZIAL	AFANDELA ESPECIAL
52	203353	4	PERNO GUIDA RUOTA	PIN	AXE	BOLZEN	PERNO
53	400368	2	ANELLO TAGLIAFILO	RING	ANNEAU	RING	ANILLO

GRUPPO BASAMENTO SPAZZANTE  
 BRUSHES BASE ASSY WITH SWEEPING SYSTEM  
 GROUPE PLATEAU DES BROSSES AVEC SYSTEME BALAYEUSE  
 GRUPPE BUERSTENGESTELL MIT WALZENANVORRICHTUNG  
 GRUPO BANCADA CEPILLOS CON SISTEMA CEPILLOS CILINDRICOS

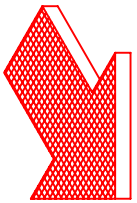
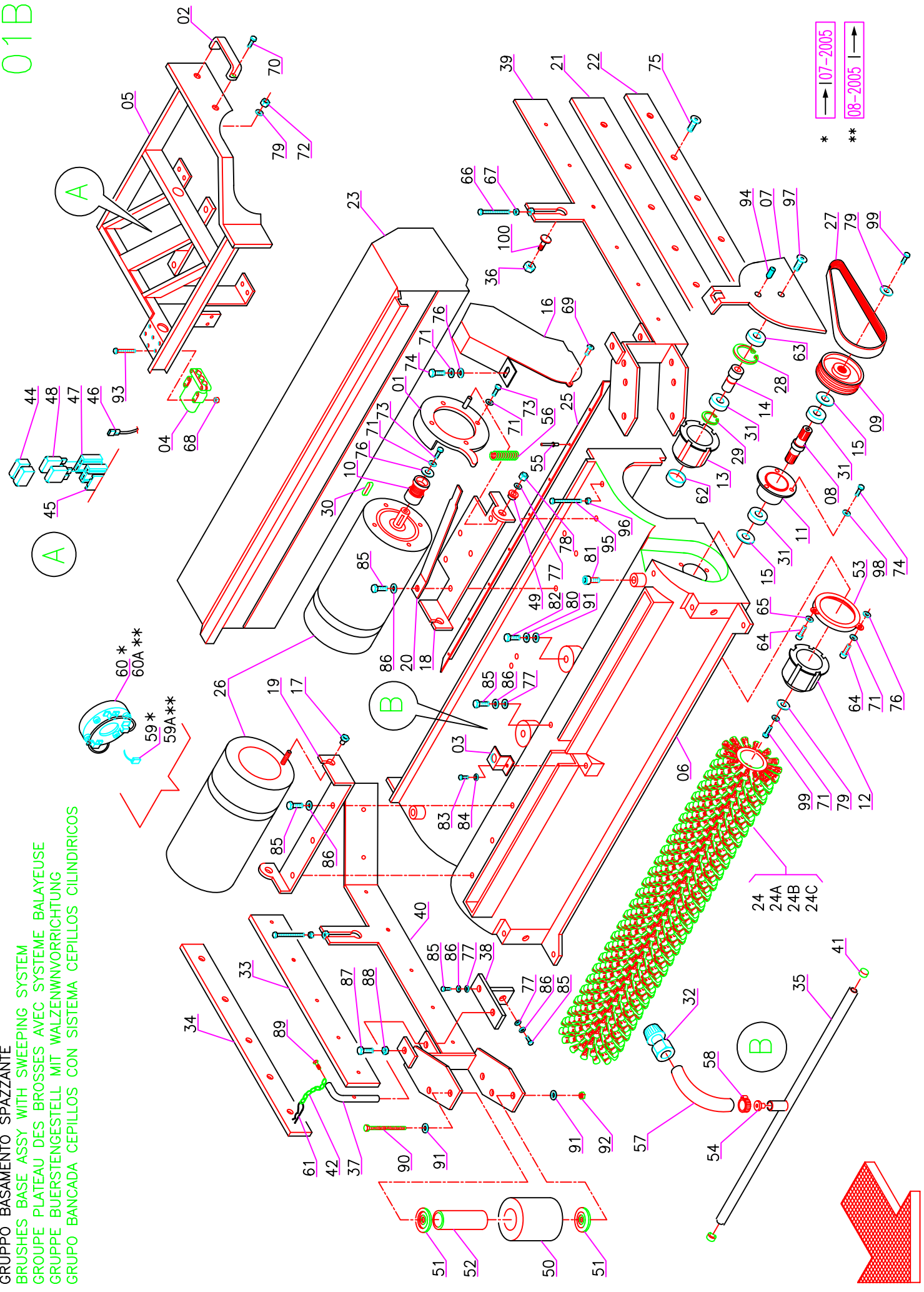

Pos. Mod.	Codice	Q.tà	Denominazione	Description	Description	Benennung	Description
54	408918	2	GRANO M8x10 NYLON	DOWEL	VIS	MADENSCHRAUBE	TORNILLO
55	409360	9	RIVETTO ALLUMINIO	RIVET	RIVET	NIET	CLAVO
56	408091	2	MOLLA A COMPRESIONE	SPRING	RESSORT	FEDER	RESORTE
57	209630	1	TUBO DI GOMMA L=640	HOSE	TUYAU	SCHLAUCH	TUBO DE GOMA
58	410293	1	FASCETTA	CLAMP	COLLIER	BRIDE	ABRAZADERA
59	409412	4	SPAZZOLA MOTORE 7X14	CARBON BRUSH MOTOR	CHARBON MOTEUR	KOHLEBÜRSTE	ESCOBILLA MOTOR
59A	409419	4	SPAZZOLA MOTORE 10X18	CARBON BRUSH MOTOR	CHARBON MOTEUR	KOHLEBÜRSTE	ESCOBILLA MOTOR
60	409722	1	ANELLO PORTASPAZZOLE	CARBON BRUSH HOLDER	PORTE-CHARBON	KOHLEBÜRSTENHALTERUNG	PORTACEPILLOS
60A	409750	1	ANELLO PORTASPAZZOLE	CARBON BRUSH HOLDER	PORTE-CHARBON	KOHLEBÜRSTENHALTERUNG	PORTACEPILLOS
61	409393	2	SPILLO Ø2.4	CLIP	EPINGLE	SPILNT	ESPIGA
62	409844	2	TAPPO PROTEZIONE	COVER	COUVERCLE	DECKEL	TAPA
63	407613	2	PARAOILIO 20X35X10	OIL SEAL	JOINT PAULSTRA	SIMMERING	AFO RASCADOR DE ACEITE
64	408797	2	VITE M6X25 TCEI UNI 5931	SCREW	VIS	SCHRAUBE	TORNILLO
65	409156	6	RONDELLA Ø6x12 UNI 6592	WASHER	RONDELLE	UNTERLAGSCHEIBE	ARANDELA
66	408657	7	VITE M6x50 TE UNI 5739 INOX	SCREW	VIS	SCHRAUBE	TORNILLO
67	409043	4	DADO M6X5 UNI 5588 INOX	NUT	ECROU	MUTTER	TUERCA
68	409080	4	DADO AUTOBL. M5 UNI 7473	LOCK NUT	ECROU AUTOBLOQUANT	STOPMUTTER	TUERCA AUTOBLOCCANTE
69	408966	4	VITE M6X16 TPSEI UNI 5933	SCREW	VIS	SCHRAUBE	TORNILLO
70	408796	4	VITE M6X20 TCEI UNI 5931	SCREW	VIS	SCHRAUBE	TORNILLO
71	409164	4	RONDELLA GROWER Ø6	LOCK WASHER	RONDELLE FREIN	SCHRAUBE	TORNILLO
72	409082	4	DADO M6 AUTOBL. UNI 7474	LOCK NUT	ECROU AUTOBLOQUANT	STOPMUTTER	TUERCA AUTOBLOCCANTE
73	407663	7	VITE M6X16 TE UNI 5739	SCREW	VIS	SCHRAUBE	TORNILLO
74	407657	7	VITE M6X10 TE UNI 5739	SCREW	VIS	SCHRAUBE	TORNILLO
75	408957	7	VITE M5X16 TPSEI UNI 5933	SCREW	VIS	SCHRAUBE	TORNILLO
76	409160	4	RONDELLA Ø6x18 UNI 6593	WASHER	RONDELLE	UNTERLAGSCHEIBE	ARANDELA
77	409175	4	RONDELLA Ø8x17 UNI 6592	WASHER	RONDELLE	UNTERLAGSCHEIBE	ARANDELA
78	409085	4	DADO AUTOBL. M8 UNI 7474	LOCK NUT	ECROU AUTOBLOQUANT	STOPMUTTER	TUERCA AUTOBLOCCANTE
79	409162	4	RONDELLA Ø6x24 UNI 6593	WASHER	RONDELLE	UNTERLAGSCHEIBE	ARANDELA
80	409196	4	RONDELLA GROWER Ø10	LOCK WASHER	RONDELLE FREIN	ZAHNSCHEIBE	ARANDELLA DENTADA
81	408810	4	VITE M8X18 TCEI UNI 5931	SCREW	VIS	SCHRAUBE	TORNILLO
82	408712	4	VITE M10X30 TE UNI 5739	SCREW	VIS	SCHRAUBE	TORNILLO
83	407648	4	VITE M5X25 TE UNI 5739 INOX	SCREW	VIS	SCHRAUBE	TORNILLO
84	409334	4	RONDELLA DENTELLATA Ø5	LOCK WASHER	RONDELLE FREIN	ZAHNSCHEIBE	ARANDELLA DENTADA
85	408670	4	VITE M8X20 TE UNI 5739	SCREW	VIS	SCHRAUBE	TORNILLO
86	409181	4	RONDELLA Ø8 GROWER	WASHER	RONDELLE	UNTERLAGSCHEIBE	ARANDELA
87	408677	4	VITE TE M8X30 INOX	SCREW	VIS	SCHRAUBE	TORNILLO
88	409048	4	DADO M8X5 INOX UNI 5589	NUT	ECROU	MUTTER	TUERCA
89	408770	4	VITE M4X12 TC UNI 6107 INOX	SCREW	VIS	SCHRAUBE	TORNILLO
90	408739	4	VITE M10X120 TE UNI 5737	SCREW	VIS	SCHRAUBE	TORNILLO
91	409191	4	RONDELLA Ø10x21 UNI 6592	WASHER	RONDELLE	UNTERLAGSCHEIBE	ARANDELA
92	409090	4	DADO AUTOBL. M10 UNI 7474	LOCK NUT	ECROU AUTOBLOQUANT	STOPMUTTER	TUERCA AUTOBLOCCANTE
93	407655	4	VITE M5X35 TE UNI 5739 INOX	SCREW	VIS	SCHRAUBE	TORNILLO
93A	408833	4	VITE M3x16 TCTC UNI 7687	SCREW	VIS	SCHRAUBE	TORNILLO
94	408918	4	GRANO M8x10 NYLON	DOWEL	VIS	MADENSCHRAUBE	TORNILLO
95	408658	4	VITE M6x60 TE INOX UNI 5739	SCREW	VIS	SCHRAUBE	TORNILLO
96	409040	4	DADO M6 UNI 5588	NUT	ECROU	MUTTER	TUERCA
97	409003	4	VITE M10x16 TPSEI UNI 5933	SCREW	VIS	SCHRAUBE	TORNILLO
98	409163	4	RONDELLA DENTELLATA Ø6	LOCK WASHER	RONDELLE FREIN	ZAHNSCHEIBE	ARANDELLA DENTADA
99	407660	4	VITE M6x12 TE INOX UNI 5739	SCREW	VIS	SCHRAUBE	TORNILLO
100	408617	4	VITE M6X25 TTQST UNI 5732	SCREW	VIS	SCHRAUBE	TORNILLO

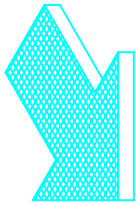
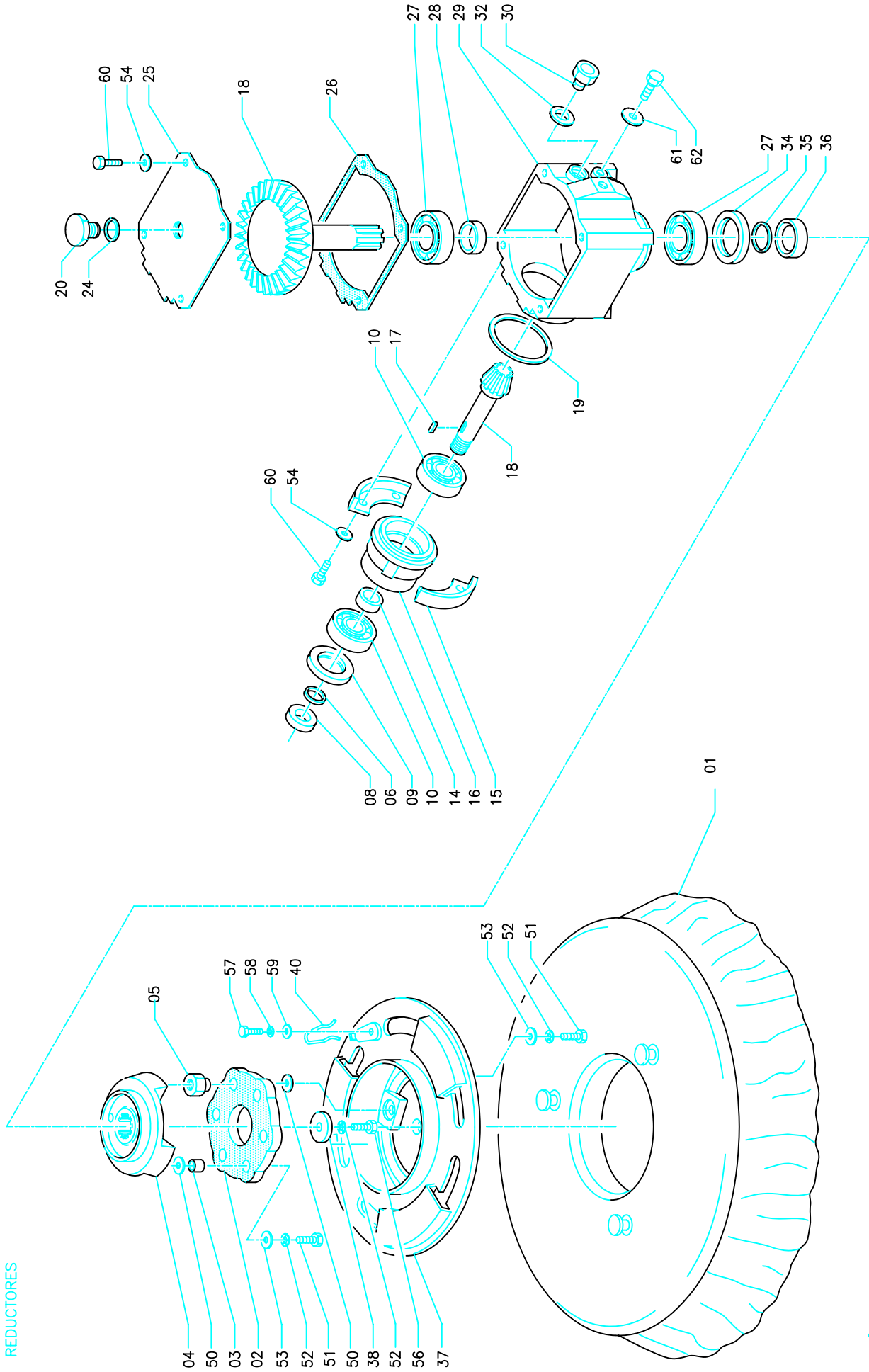

Pos. Mod.	Codice	Q.tà	Denominazione	Description	Description	Benennung	Description
01	-	2	SPAZZOLA	BRUSH	BROSSE	BÜRSTE	CEPILLO
02	400425	2	GIUNTO ELASTICO	COUPLING	ENTRAINEMENT	KUPPLUNG	ACOPPLAMINETO
03	202451	6	DISTANZIALE	SPACER	ENTRETOISE	DISTANZHÜLSE	DISTANCIADOR
04	205989	2	FLANGIA	FLANGE	FLASQUE	FLANSCH	BRIDA
05	202467	6	BOCCOLA	BUSHING	BAGUE	BUCHSE	CASQUILLO
06	408501	2	GUARNIZIONE OR 3068	O-RING	JOINT	O-RING	JUNTA ANULAR
08	407982	2	DISTANZIALE	SPACER	ENTRETOISE	DISTANZHÜLSE	DISTANCIADOR
09	407618	2	PARAOLIO Ø30x47x7	OIL SEAL	JOINT PAULSTRA	SIMMERING	AFO RASCADOR DE ACEITE
10	408431	4	CUSCINETTO 6303	BEARING	ROULEMENT	LAGER	COJINETE
14	202393	2	DISTANZIALE	SPACER	ENTRETOISE	DISTANZHÜLSE	DISTANCIADOR
15	400168	4	MORSETTO	HOLDFAST	ETAU	KLEMMME	MORDAZA
16	206075	2	SUPPORTO	SUPPORT	SUPPORT	HALTERUNG	SOPORTE
17	408403	2	CHIAVETTA-5X5X18 UNI 6604/69	KEY	CLAVETTE	KEIL	CLAVIJA
18	408136	1	COPPIA CONICA RIDUTT. DX (1:4.5)	BEVEL GEAR PAIR RIGHT RED.	PAIR CONIQUE RED. DROITE	KEGELRADPAARUNG, RECHTS	PAR RUEDAS CON. RED. DER.
19	408137	1	COPPIA CONICA RIDUTT. SN (1:4.5)	BEVEL GEAR PAIR LEFT RED.	PAIR CONIQUE RED. GAUCHE	KEGELRADPAARUNG, LINKS	PAR RUEDAS CON. RED. IZO.
20	410400	2	TAPPO CON SFIATO	GASKET	JOINT	DICHTUNG	JUNTA
24	405901	2	GUARNIZIONE	BREATHER	BOUCHON	STÖPSEL	RESPIRADERO
25	203561	2	COPERCHIO RIDUTTORE	GASKET	JOINT	DICHTUNG	JUNTA
26	405927	2	GUARNIZIONE	COVER REDUCTION GEAR	COUVERCLE DE REDUCTEUR	GETRIEBEDECKEL	TAPA DE REDUCTOR
27	408440	4	CUSCINETTO 6205	GASKET	JOINT	DICHTUNG	JUNTA
28	202394	2	DISTANZIALE	BEARING	ROULEMENT	LAGER	COJINETE
29	206074	2	SCATOLA RIDUTTORE	SPACER	ENTRETOISE	DISTANZHÜLSE	DISTANCIADOR
30	410404	2	TAPPO LIVELLO	REDUCTION GEAR BOX	BOITIER REDUCTEUR	GETRIEBEGEHÄUSE	CAJA REDUCTOR
32	405917	2	GUARNIZIONE	LEVEL PLUG	JOINT	DICHTUNG	TAPON NIVEL
34	407623	2	PARAOLIO Ø38x52x8	GASKET	JOINT PAULSTRA	SIMMERING	JUNTA
35	408500	2	GUARNIZIONE OR 3100	OIL SEAL	JOINT	O-RING	AFO RASCADOR DE ACEITE
36	407591	2	DISTANZIALE	SPACER	ENTRETOISE	DISTANZHÜLSE	JUNTA ANULAR
37	205990	2	PIATTO PORTASPAZZOLA	BRUSH PLATE	PLATEAU DE BROSSE	BÜRSTENTRÄGER	DISTANCIADOR
38	400167	2	RONDELLA SPECIALE	SPECIAL WASHER	RONDELLE SPECIALE	UNTERLAGSCHEIBE SPEZIAL	PLATO PORTACEPILLO
40	408124	2	MOLLA	SPRING	RESSORT	FEDER	ARANDELA ESPECIAL
50	409343	2	RONDELLA Ø8x18 CONTACT	WASHER	RONDELLE	UNTERLAGSCHEIBE	RESORTE
51	408676	2	VITE M8x30 TE UNI 5739	SCREW	VIS	SCHRAUBE	ARANDELA
52	409181	2	RONDELLA Ø8 GROWER	WASHER	RONDELLE	UNTERLAGSCHEIBE	TORNILLO
53	409179	2	RONDELLA Ø9x24 UNI 6593	WASHER	RONDELLE	UNTERLAGSCHEIBE	ARANDELA
54	409341	2	RONDELLA Ø8 SCHNORR	SPLIT WASHER	RONDELLE ELASTIQUE	FEDERRING	ARANDELA
56	408810	2	VITE M8x18 TCEI UNI 5931	SCREW	VIS	SCHRAUBE	TORNILLO
57	407658	2	VITE M6x10 TE UNI 5739 INOX	SCREW	VIS	SCHRAUBE	TORNILLO
58	409164	2	RONDELLA GROWER Ø6	LOCK WASHER	RONDELLE FREIN	ZAHNSCHEIBE	ARANDELA DENTADA
59	409162	2	RONDELLA Ø6x24 UNI 6593	WASHER	RONDELLE	UNTERLAGSCHEIBE	ARANDELA
60	408670	2	VITE M8x20 TE UNI 5739	SCREW	VIS	SCHRAUBE	TORNILLO
61	409190	2	RONDELLA Ø10x16 AL	WASHER	RONDELLE	SCHRAUBE	ARANDELA
62	408707	2	VITE M10x12 TE UNI 5739	SCREW	VIS	SCHRAUBE	TORNILLO

GRUPPO COMANDO SPAZZOLE  
BRUSHES CONTROL ASSEMBLY  
GROUPE COMMANDE DES BROSSES  
GRUPPE BUERSTENBETAETIGUNG  
GRUPO MANDO CEPILLOS

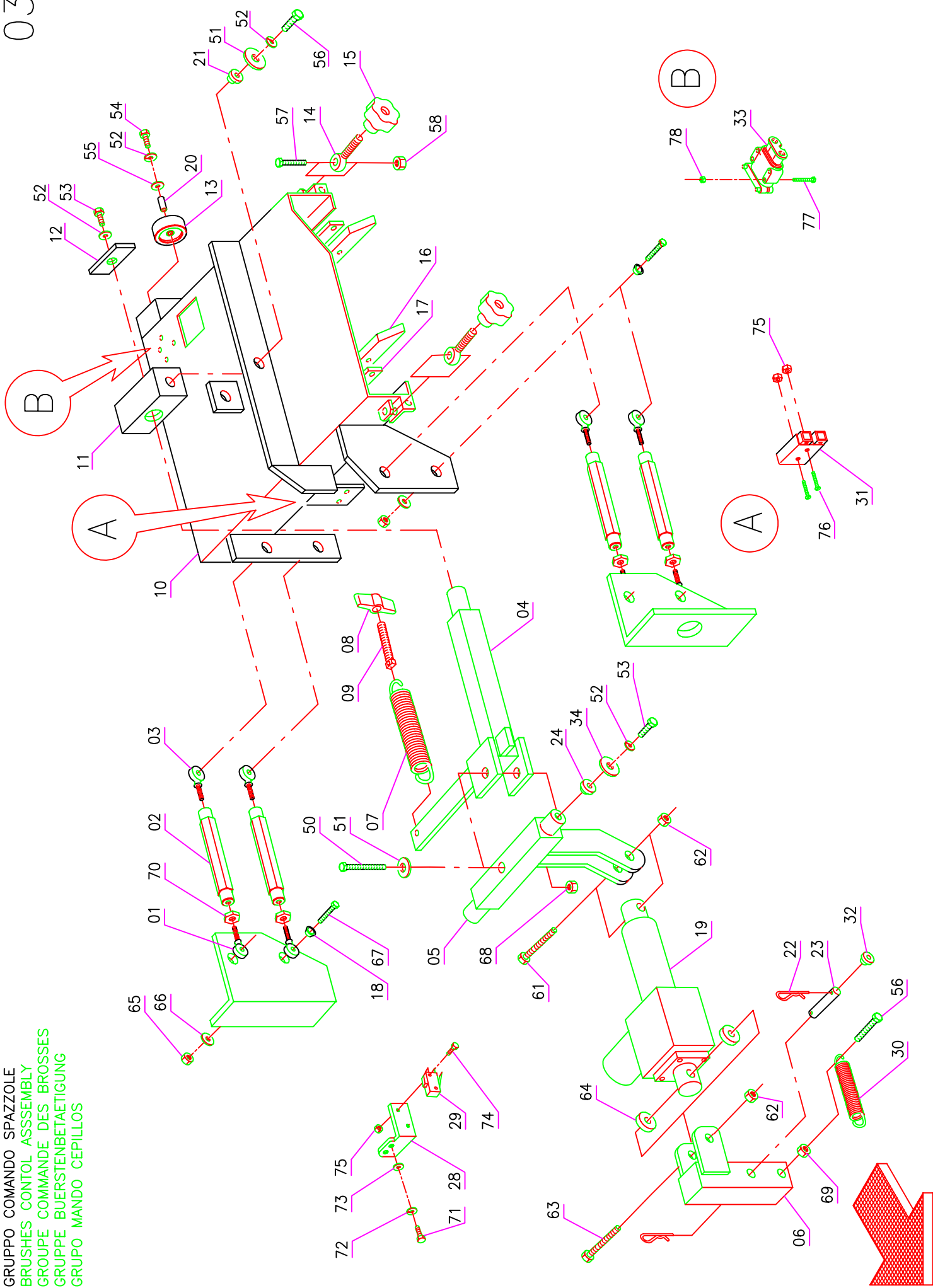

Pos. Mod.	Codice	Q.tà	Denominazione	Description	Description	Benennung	Description
01	408472	4	TESTA A SNODO	ARTICULATION HEAD	TETE ARTICULEE	KOPFGELENK	TESTA DE ARTICULACION
02	204376	4	BRACCIO ANTERIORE	ARM	BRAS	ARM	BRASO
03	408471	4	TESTA A SNODO	ARTICULATION HEAD	TETE ARTICULEE	KOPFGELENK	TESTA DE ARTICULACION
04	206590	1	BRACCIO	ARM	BRAS	ARM	BRASO
05	206589	1	ALBERO	SHAFT	ARBRE	WELLE	EJE
06	206588	1	ATTACCO	COUPLING	ATTAQUE	KUPPLUNG	ACOPLAMIENTO
07	408114	1	MOLLA TRAZIONE	SPRING	RESSORT	FEDER	RESORTE
08	410237	1	GALLETTO M8	KNOB	POMMEAU	RENDELSCHRAUBE	POMO
09	206061	1	REGISTRO	ADJUSTER	REGISTRE	REGISTER	REGULADOR
10	203617	1	SUPPORTO	SUPPORT	SUPPORT	HALTERUNG	SOPORTE
11	206591	1	BLOCCETTO	BLOCK	PETIT BLOC	ARRETIERUNG	BLOQUE
12	204946	1	PIASTRINA	PLAQUE	PLAQUETTE	BEFESTIGUNGSAUFLAGE	PLAQUETA
13	405707	1	RUOTA PARACOLPI	WHEEL	ROUE	RAD	RUEDA
14	410547	2	TIRANTE	TIE ROD	TIGE	SPANNSTANGE	TIRANTE
15	410234	2	POMELLO VB40 M8	KNOB	POMMEAU	RENDELSCHRAUBE	POMO
16	400744	2	GUIDA	GUIDE	GUIDE	FUHRUNG	GUIA
17	203619	2	SPESSORE	SHIM	EPAISSEUR	BELAGERING	ESPESOR
18	210103	16	DISTANZIALE	SPACER	ENTRETOISE	DISTANZHUELSE	DISTANCIADOR
19	404762	1	MARTINETTO COMPLETO	ACTUATOR ASSEMBLY	VERIN COMPLET	SPINDELMOTOR KOMPLETT	GATO COMPLETO
20	408033	1	BOCCOLA	BUSHING	BAGUE	BUCHSE	CASQUILLO
21	408020	2	BOCCOLA	BUSHING	BAGUE	BUCHSE	CASQUILLO
22	409393	2	SPILLO Ø2.4	CLIP	EPINGLE	SPLINT	ESPIGA
23	206592	1	PERNO	PIN	AXE	BOLZEN	PERNO
24	408040	2	BOCCOLA	BUSHING	BAGUE	BUCHSE	CASQUILLO
28	203620	1	STAFFA	SUPPORT	ATTAQUE	HALTERUNG	SOPORTE FIJADOR
29	409498	1	MICROINTERRUTTORE	MICROSWITCH	MICROINTERRUPTEUR	MIKROSCHALTER	MICROINTERRUPTOR
30	408110	1	MOLLA TRAZIONE	SPRING	RESSORT	FEDER	RESORTE
31	204355	1	CONNETTORE F.50A	CONNECTOR	CONNECTEUR	LADESTECKER	CONECTOR
32	408081	2	BOCCOLA	BUSHING	BAGUE	BUCHSE	CASQUILLO
33	409667	1	CONNETTORE F.80A	CONNECTOR FEMALE	CONNECTEUR FEMELLE	STECKER OHNE ZAPFEN	CONECTOR HEMBRA
34	400167	2	ROSETTA SPECIALE	SPECIAL WASHER	RONDELLE SPECIALE	UNTERLAGSCHEIBE SPEZIAL	ARANDELA ESPECIAL
50	408740		VITE M10x70 TE UNI 5737	SCREW	VIS	SCHRAUBE	TORNILLO
51	409192		RONDELLA Ø10x21 UNI 6592	WASHER	RONDELLE	UNTERLAGSCHEIBE	ARANDELA
52	409181		RONDELLA Ø8 GROWER	WASHER	RONDELLE	UNTERLAGSCHEIBE	ARANDELA
53	408670		VITE M8x20 TE UNI 5739	SCREW	VIS	SCHRAUBE	TORNILLO
54	408678		VITE M8x35 TE UNI 5739	SCREW	VIS	SCHRAUBE	TORNILLO
55	409175		RONDELLA Ø8x17 UNI 6592	WASHER	RONDELLE	UNTERLAGSCHEIBE	ARANDELA
56	408674		VITE M8x25 TE UNI 5739	SCREW	VIS	SCHRAUBE	TORNILLO
57	407671		VITE M6x30 TE UNI 5739 INOX	SCREW	VIS	SCHRAUBE	TORNILLO
58	409041		DADO M6 INOX UNI 5587	NUT	EGROU	MUTTER	TUERCA
59	408669		VITE M8x16 TE UNI 5739	SCREW	VIS	SCHRAUBE	TORNILLO
60	400167		RONDELLA SPECIALE	SPECIAL WASHER	RONDELLE SPECIALE	UNTERLAGSCHEIBE SPEZIAL	ARANDELA ESPECIAL
61	408730		VITE M10x60 TE UNI 5737	SCREW	VIS	SCHRAUBE	TORNILLO
62	409090		DADO AUTOBL. M10 UNI 7474	LOCK NUT	ECROU AUTOBLOQUANT	STOPMUTTER	TUERCA AUTOBLOCCANTE
63	408727		VITE M10x70 TE UNI 5737	SCREW	VIS	SCHRAUBE	TORNILLO
64	409191		RONDELLA Ø10x21 UNI 6592	WASHER	RONDELLE	UNTERLAGSCHEIBE	ARANDELA
65	409093		DADO M12 AUTOBL. UNI 7473	LOCK NUT	ECROU AUTOBLOQUANT	STOPMUTTER	TUERCA AUTOBLOCCANTE
66	409201		RONDELLA Ø12x24 UNI 6592	WASHER	RONDELLE	UNTERLAGSCHEIBE	ARANDELA
67	408749		VITE M12x60 TE UNI 5737	SCREW	VIS	SCHRAUBE	TORNILLO
68	409091		DADO M10 AUTOBL. INOX 7474	LOCK NUT	ECROU AUTOBLOQUANT	STOPMUTTER	TUERCA AUTOBLOCCANTE
69	409052		DADO M8 UNI 5587	NUT	ECROU	MUTTER	TUERCA
70	409067		DADO M12 UNI 5589	NUT	ECROU	MUTTER	TUERCA
71	407644		VITE M5x12 TE UNI 5739	SCREW	VIS	SCHRAUBE	TORNILLO
72	409154		ROSETTA GROWER Ø5	WASHER	RONDELLE	SCHIBE	ARANDELA
73	409150		RONDELLA Ø5x11 UNI 6592	WASHER	RONDELLE	UNTERLAGSCHEIBE	ARANDELA
74	408833		VITE M3x16 TCTC UNI 7687	SCREW	VIS	SCHRAUBE	TORNILLO
75	409077		DADO AUTOBL. M3 UNI 7473	LOCK NUT	ECROU AUTOBLOQUANT	STOPMUTTER	TUERCA AUTOBLOCCANTE
76	408835		VITE M3x25 TCTC UNI 7687 ZINC	SCREW	VIS	SCHRAUBE	TORNILLO
77	408668		VITE M4x40 TE UNI 5739	SCREW	VIS	SCHRAUBE	TORNILLO
78	409078		DADO AUTOBL. M4 UNI 7473	LOCK NUT	ECROU AUTOBLOQUANT	STOPMUTTER	TUERCA AUTOBLOCCANTE

GRUPPO STERZO  
STEERING GEAR  
ENSEMBLE DE VOLANT  
LENKGRUPPE  
GRUPO DE DIRECCION

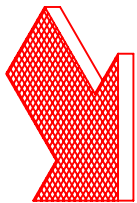
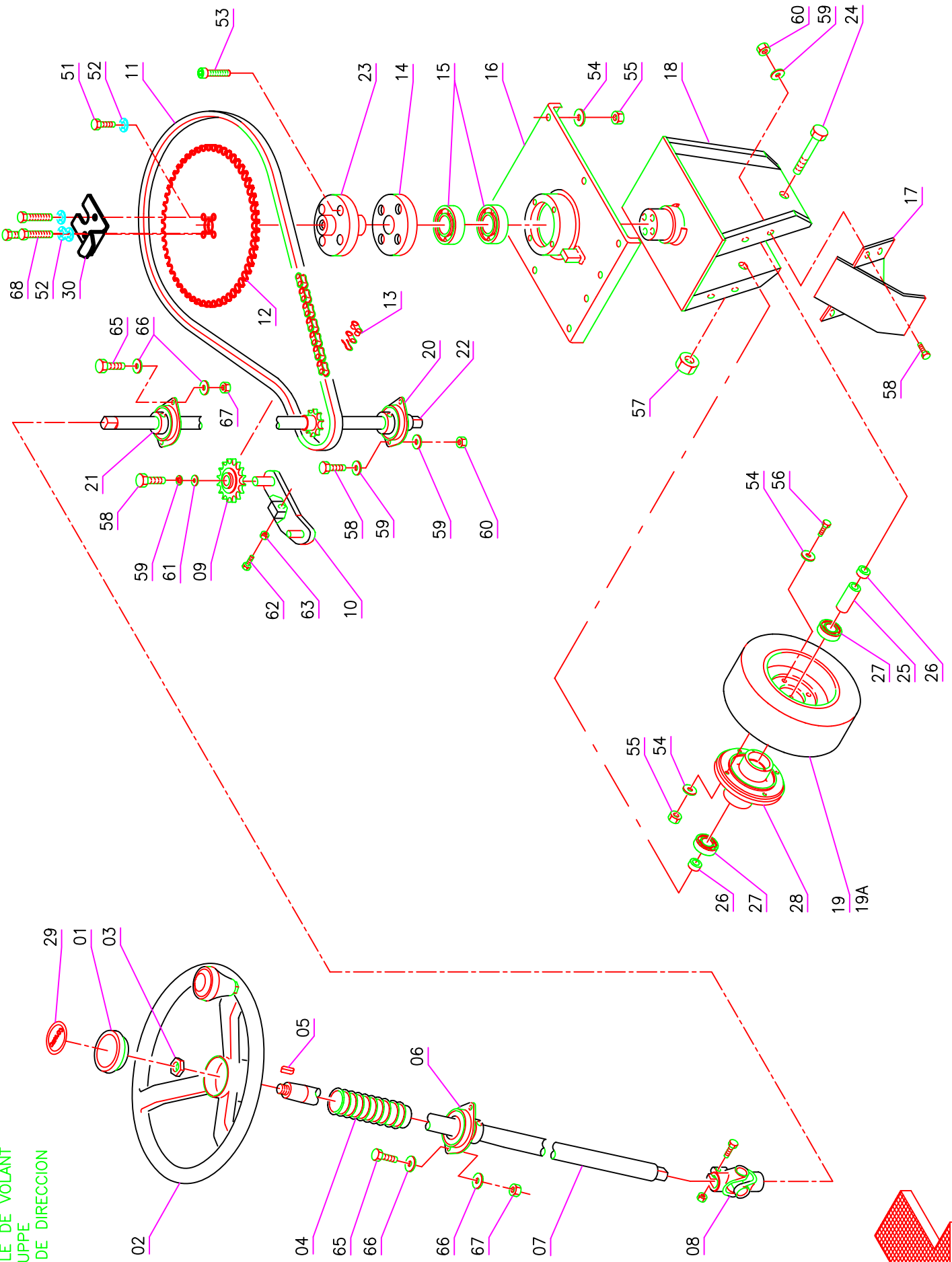



Pos.	Mod.	Codice	Q.tà	Denominazione	Description	Description	Benennung	Description
01		409845	1	TAPPO	CAP	CAPUCHON	KAPPE	TAPON
02		408171	1	VOLANTE COMPLETO	STEERING WHEEL ASSEMBLY	VOLANT COMPLET	LENKRAD KOMPLETT	VOLANTE COMPLETO
03		205250	1	DADO SPECIALE	SPECIAL NUT	ECROU SPECIALE	SPEZIALMUTTER	TUERCA ESPECIAL
04		405485	1	SOFFIETTO	BELLOWS	SOUFFLET	FALTENBALG	FUELLE
05		408405	1	CHIAVETTA 5x5x25 UNI 6604/69	KEY	CLAVETTE	KEIL	CLAVIJA
06		408479	1	CUSCINETTO	BEARING	ROULEMENT	LAGER	COJINETE
07		206719	1	ALBERO	SHAFT	ARBRE	WELLE	EJE
08		410558	1	GIUNTO CARDANICO	UNIVERSAL JOINT	JOINT UNIVERSEL	KREUZGELENK	ARTICULACION DE CARDAN
09		407603	1	TENDICATENA	CHAIN TIGHTENER	TENDEUR DE CHAINE	KETTENSPIANNER	TENSOR DE CADENA
10		203631	1	SUPPORTO	SUPPORT	SUPPORT	HALTERUNG	SOPORTE
11		408383	1	CATENA 1/2X57	CHAIN	CHAINE	KETTE	CADENA
12		203630	1	CORONA 1/2"x5/16" Z=56	CROWN GEAR	COURONNE	ZAHNKETTENRAD	CORONA DENTADA
13		408380	1	GIUNTO CATENA	JOINT CHAIN	ATTACHE RAPID CHAINE	KETTENSCHLOSS	ESLABON
14		203981	1	SUPPORTO CUSCINETTO	BEARING SUPPORT	SUPPORT ROULEMENT	LAGERHALTERUNG	SOPORTE COJINETE
15		408450	2	CUSCINETTO 6010 2RS	BEARING	ROULEMENT	LAGER	COJINETE
16		400780	1	PIASTRA SUPPORTO	PLAQUE	PLAQUE	BEFESTIGUNGSAUFLAGE	PLACA
17		400779	1	PARAFANGO	FENDER	GARDE-BOUE	ABDECKUNG	GUARDABARROS
18		400778	1	SUPPORTO RUOTA ANTERIORE	SUPPORT WHEELS	SUPPORT ROUES	HALTERUNG RÄDER	SOPORTE RUEDAS
19		405458	1	RUOTA D.250X90 ANTISKID	WHEEL	ROUE	RAD	RUEDA
19A		405727	1	RUOTA D250X90 GOMMA ANTITR.	WHEEL	ROUE	RAD	RUEDA
20		408474	1	SUPPORTO CUSCINETTO	BEARING SUPPORT	SUPPORT ROULEMENT	LAGERHALTERUNG	SOPORTE COJINETE
21		408476	1	SUPPORTO OVALE	SUPPORT	SUPPORT	HALTERUNG	SOPORTE
22		206720	1	ALBERO STERZO	SHAFT	ARBRE	WELLE	EJE
23		203951	1	MOZZO	HUB	MOYEU	NABE	CUBO
24		206721	1	PERNO	PIN	AXE	BOLZEN	PERNO
25		210196	1	DISTANZIALE	SPACER	ENTRETOISE	BOLZEN	PERNO
26		202444	2	DISTANZIALE	SPACER	ENTRETOISE	DISTANZHÜLSE	DISTANCIADOR
27		408435	2	CUSCINETTO 6204-RS	BEARING	ROULEMENT	LAGER	COJINETE
28		202049	1	MOZZO RUOTA	WHEEL HUB	MOYEU ROUE	RADNABE	CUBO DE RUEDA
29		404930	1	ETICHETTA -COMAG-	DECAL	ETIQUETTE	SCHILD	ETIQUETA
30		206726	1	CAMMA	CAM WHEEL	CAME	NOCKEN	LEVA
50		408983	1	VITE M8X40 TPSEI UNI 5933	SCREW	VIS	SCHRAUBE	TORNILLO
51		408703	1	VITE M8x40 TE UNI 5739	SCREW	VIS	SCHRAUBE	TORNILLO
52		409340	1	RONDELLA DENTELLATA Ø8	LOCK WASHER	RONDELLE FREIN	SCHRAUBE	AFANDELA DENTADA
53		408824	1	VITE M10x30 TCEI UNI 5931	SCREW	VIS	SCHRAUBE	TORNILLO
54		409191	1	RONDELLA Ø10x21 UNI 6592	WASHER	RONDELLE	UNTERLAGSCHEIBE	AFANDELA
55		409090	1	DADO AUTOBL. M10 UNI 7474	LOCK NUT	ECROU AUTOBLOQUANT	STOPMUTTER	TUERCA AUTOBLOCCANTE
56		408714	1	VITE M10X35 TE UNI 5739	SCREW	VIS	SCHRAUBE	TORNILLO
57		409100	1	DADO AUTOBL.	LOCK NUT	ECROU AUTOBLOQUANT	STOPMUTTER	TUERCA AUTOBLOCCANTE
58		407663	1	VITE M6X16 TE UNI 5739	SCREW	VIS	SCHRAUBE	TORNILLO
59		409156	1	RONDELLA Ø6x12 UNI 6592	WASHER	RONDELLE	UNTERLAGSCHEIBE	AFANDELA
60		409082	1	DADO M6 AUTOBL. UNI 7474	LOCK NUT	ECROU AUTOBLOQUANT	STOPMUTTER	TUERCA AUTOBLOCCANTE
61		409162	1	RONDELLA Ø6x24 UNI 6593	WASHER	RONDELLE	UNTERLAGSCHEIBE	AFANDELA
62		408693	1	VITE M8x60 TE UNI 5739	SCREW	VIS	SCHRAUBE	TORNILLO
63		409052	1	DADO M8 UNI 5587	NUT	ECROU	MUTTER	TUERCA
64		409211	1	RONDELLA Ø15x28 UNI 6592	WASHER	RONDELLE	UNTERLAGSCHEIBE	AFANDELA
65		408670	1	VITE M8X20 TE UNI 5739	SCREW	VIS	SCHRAUBE	TORNILLO
66		409175	1	RONDELLA Ø8x17 UNI 6592	WASHER	RONDELLE	UNTERLAGSCHEIBE	AFANDELA
67		409085	1	DADO AUTOBL. M8 UNI 7474	LOCK NUT	ECROU AUTOBLOQUANT	STOPMUTTER	TUERCA AUTOBLOCCANTE
68		408681	1	VITE M8X45 TE UNI 5739	SCREW	VIS	SCHRAUBE	TORNILLO

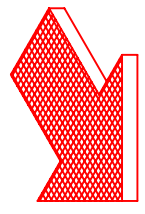
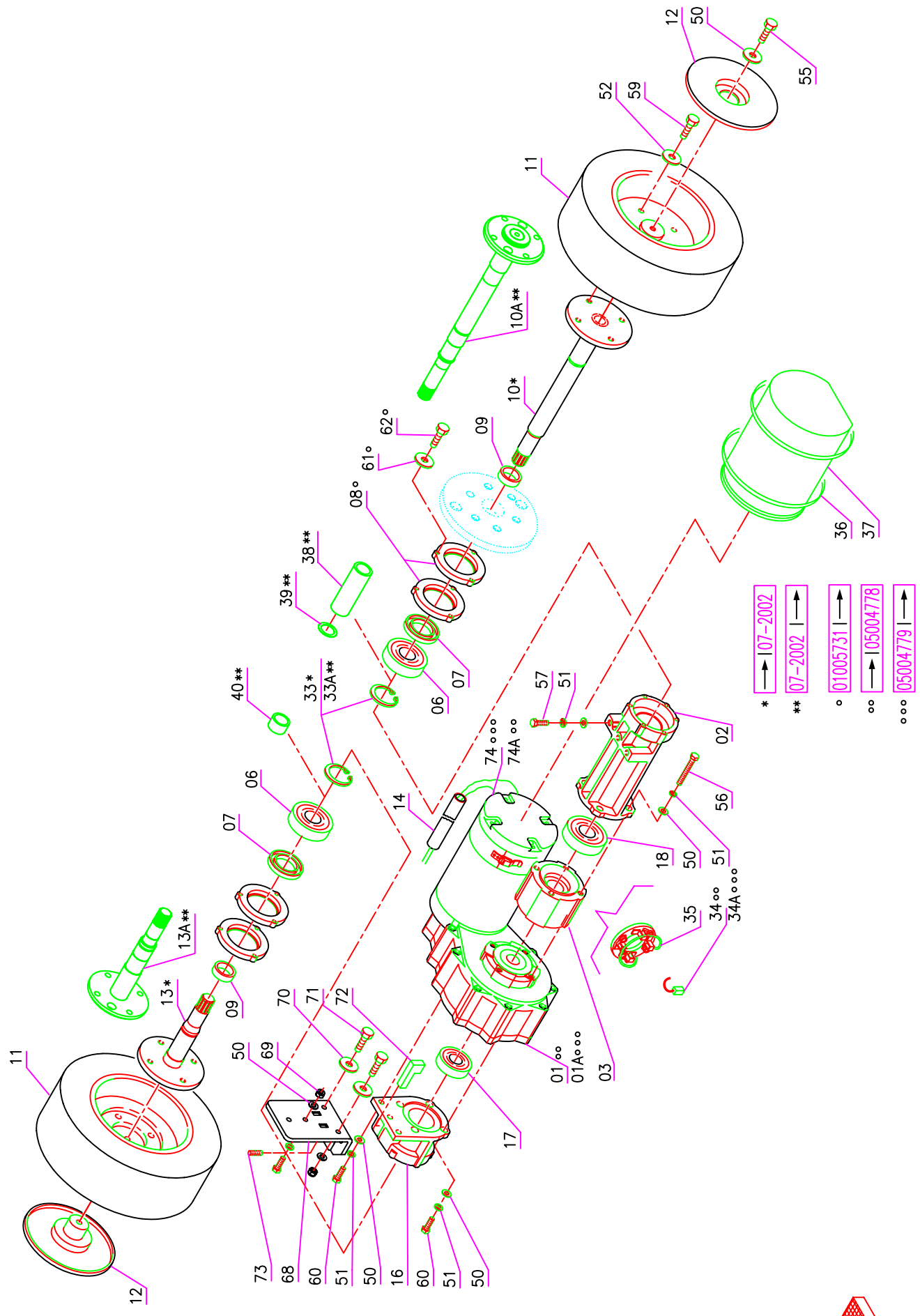

Pos. Mod.	Codice	Q.tà	Denominazione	Description	Description	Benennung	Description
01	407541	1	MOTORIDUTTORE 36V 450W	GEARED MOTOR	MOTO-REDUCTEUR	GETRIEBEMOTOR	MOTORREDUCTOR
01A	412584	1	MOTORIDUTTORE 36V 600W	GEARED MOTOR	MOTO-REDUCTEUR	GETRIEBEMOTOR	MOTORREDUCTOR
02	205469	1	SUPPORTO SX	LEFT SUPPORT	SUPPORT GAUCHE	HALTERUNG LINKS	SOPORTE IZQUIERDO
03	410136	1	DISTANZIALE MOTORIDUTTORE	SPACER	ENTRETOISE	DISTANZHÜLSE	DISTANCIADOR
06	408442	2	CUSCINETTO SF.6305-2RS	BEARING	ROULEMENT	LAGER	COJINETE
07	407621	2	PARAOLIO Ø32x52x7	OIL SEAL	JOINT PAULSTRA	SIMMERING	AFO RASCADOR DE ACEITE
08	400382	4	COPERCHIO SUPPORTO	COVER	COUVERCLE	DECKEL	TAPA
09	407595	2	DISTANZIALE	SPACER	ENTRETOISE	DISTANZHÜLSE	DISTANCIADOR
10	407969	1	SEMIASSE SX	LEFT AXLE SHAFT	DEMI-ESSIEU GAUCHE	ACHSWELLE LINKS	SEMIEJE IZQUIERDO
10A	407971	1	SEMIASSE SX	LEFT AXLE SHAFT	DEMI-ESSIEU GAUCHE	ACHSWELLE LINKS	SEMIEJE IZQUIERDO
11	405459	2	RUOTA POSTERIORE	WHEEL	ROUE	RAD	RUEDA
12	400536	2	DISCO COPRIRUOTA	WHEEL COVER	COUVERCLE DE ROUE	RADDECKEL	CUBRERUEDA
13	407968	1	SEMIASSE DX	RIGHT AXLE SHAFT	DEMI-ESSIEU DROITE	ACHSWELLE RECHTS	SEMIEJE DERECHO
13A	407970	1	SEMIASSE DX	RIGHT AXLE SHAFT	DEMI-ESSIEU DROITE	ACHSWELLE RECHTS	SEMIEJE DERECHO
14	209371	1	GUAINA	SHEATH	GAINÉ	SCHUTZMANTEL	VAINA
16	205468	1	SUPPORTO ASSE DX	SUPPORT	SUPPORT	HALTERUNG	SOPORTE
17	408434	1	CUSCINETTO SF.6004-2RS	BEARING	ROULEMENT	LAGER	COJINETE
18	408437	1	CUSCINETTO SF.6304-2RS	BEARING	ROULEMENT	LAGER	COJINETE
33	408355	2	SEEGER E25x1.2	SEEGER RING	SERRE CLIPS	SEEGERRING	ANILLO SEEGER
33A	408364	2	SEEGER E25x2	SEEGER RING	SERRE CLIPS	SEEGERRING	ANILLO SEEGER
34	409412	4	SPAZZOLA MOTORE 07X14	CARBON BRUSH MOTOR	CHARBON MOTEUR	KOHLEBÜRSTE	ESCOBILLA MOTOR
34A	409419	4	SPAZZOLA MOTORE 10X18	CARBON BRUSH MOTOR	CHARBON MOTEUR	KOHLEBÜRSTE	ESCOBILLA MOTOR
35	409744	1	ANELLO PORTASPAPAZZOLE	CARBON BRUSH HOLDER	PORTE-CHARBON	KOHLEBÜRSTENHALTERUNG	PORTACEPILLOS
36	410276	2	FASCETTA 4.8X360	CLAMP	COLLIER	BRIDE	ABRAZADERA
37	405944	1	CUFFIA MOTORE	SHROUD	JOINT	LAGERRING	ANILLO
38	202447	1	DISTANZIALE L=99	SPACER	ENTRETOISE	DISTANZHÜLSE	DISTANCIADOR
39	409320	1	SPessore RAM	SHIM RING	ANNEAU DE CALAGE	BEILEGERING	ANILLO DE RELLENO
40	210104	1	DISTANZIALE	SPACER	ENTRETOISE	DISTANZHÜLSE	DISTANCIADOR
50	409175	1	RONDELLA Ø8x17 UNI 6592	WASHER	RONDELLE	UNTERLAGSCHEIBE	ARANDELA
51	409181	1	RONDELLA Ø8 GROWER	WASHER	RONDELLE	UNTERLAGSCHEIBE	ARANDELA
52	409196	1	RONDELLA GROWER Ø10	LOCK WASHER	RONDELLE FREIN	ZAHNSCHEIBE	ARANDELLA DENTADA
55	408674	1	VITE M8x25 TE UNI 5739	SCREW	VIS	SCHRAUBE	TORNILLO
56	408693	1	VITE M8x60 TE UNI 5739	SCREW	VIS	SCHRAUBE	TORNILLO
57	408669	1	VITE M8x16 TE UNI 5739	SCREW	VIS	SCHRAUBE	TORNILLO
59	408826	1	VITE M10x20 TCEI UNI 5931	SCREW	VIS	SCHRAUBE	TORNILLO
60	408672	1	VITE M8x22 TE UNI 5739	SCREW	VIS	SCHRAUBE	TORNILLO
61	409164	1	RONDELLA GROWER Ø6	LOCK WASHER	RONDELLE FREIN	ZAHNSCHEIBE	ARANDELLA DENTADA
62	408802	1	VITE M6x40 TCEI UNI 5931	SCREW	VIS	SCHRAUBE	TORNILLO
68	206682	1	RINFORZO SUPPORTO RUOTE	REINFORCEMENT	REINFORCEMENT	VERSTÄRKUNG	REFUERZO
69	409085	1	DADO M8x8.5 AUTOBL. UNI 7474	LOCK NUT	ECROU AUTOBLOQUANT	STOPMUTTER	TUERCA AUTOBLOCANTE
70	409179	1	RONDELLA Ø9x24 UNI 6593	WASHER	RONDELLE	UNTERLAGSCHEIBE	ARANDELA
71	408674	1	VITE M8x25 TE UNI 5739	SCREW	VIS	SCHRAUBE	TORNILLO
72	206683	1	STAFFA DI RINFORZO	SUPPORT	ATTAQUE	HALTERUNG	SOPORTE FIJADOR
73	206680	1	PERNO FILETTATO M10	PIN	AXE	BOLZEN	PERNO
74	407732	1	MOTORE 36V 600W	MOTOR	MOTEUR	MOTOR	MOTOR
74A	407781	1	MOTORE 36V 450W	MOTOR	MOTEUR	MOTOR	MOTOR

GRUPPO TRAZIONE -KIT RUOTE GEMELLATE  
TRACTION ASSEMBLY - TWIN WHEELS KIT  
GROUPE DE TRACTION - KIT ROUE JUMEAU  
ANTRIEBSGRUPPE - KIT PAARIG RADER  
GRUPO TRACCION - KIT RUEDAS GEMELAS

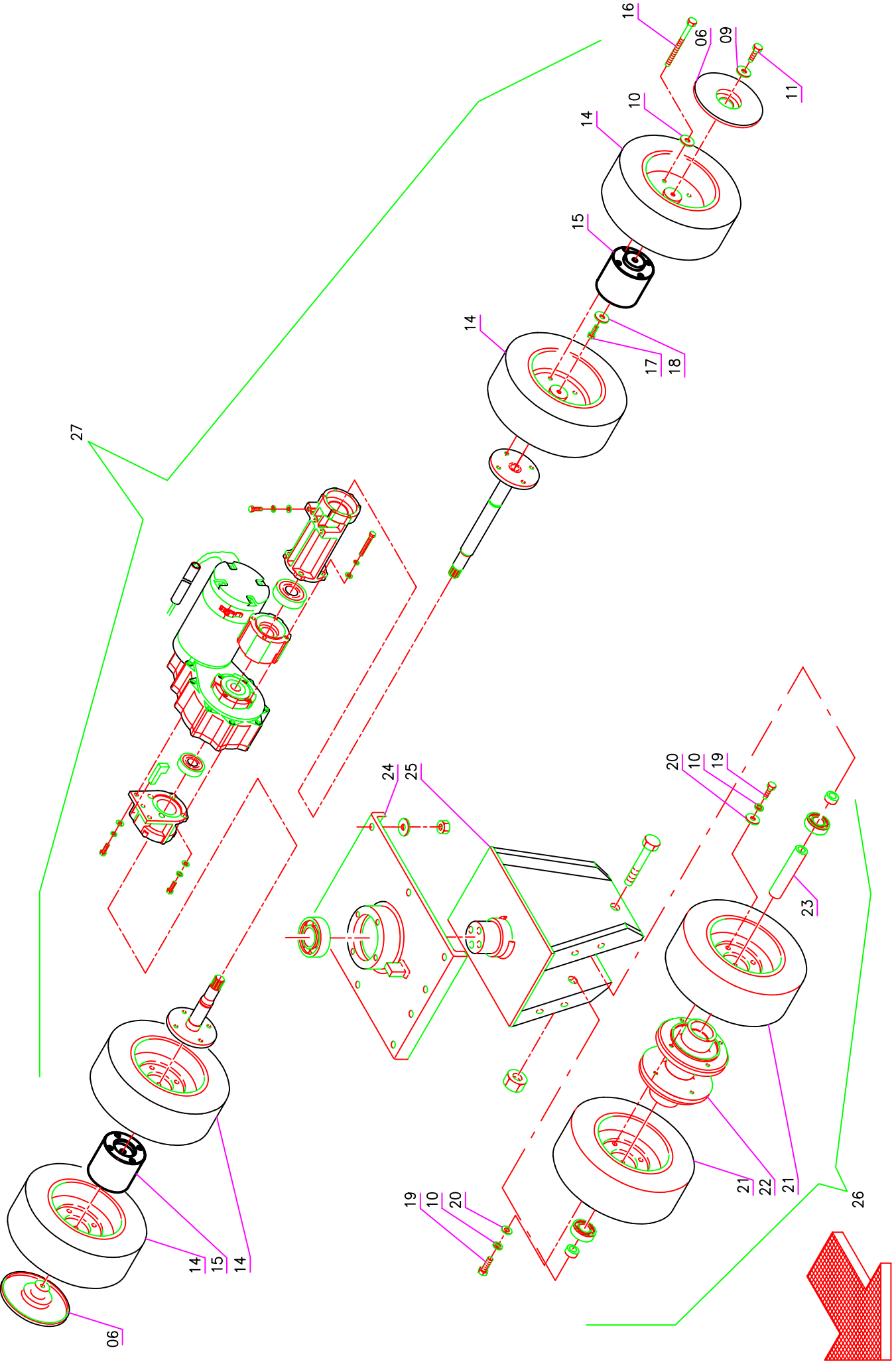

Pos. Mod.	Codice	Q.tà	Denominazione	Description	Description	Benennung	Description
06	400536	2	DISCO COPRIRUOTA	WHEEL COVER	COUVERCLE DE ROUE	RADDECKEL	CUBRERUEDA
09	409175	2	RONDELLA Ø8x17 UNI 6592	WASHER	RONDELLE	UNTERLAGSCHEIBE	ARANDELA
10	409196	8	RONDELLA GROWER Ø10	LOCK WASHER	RONDELLE FREIN	ZAHNSCHEIBE	ARANDELLA DENTADA
11	408674	2	VITE M8x25 TE UNI 5739	SCREW	VIS	SCHRAUBE	TORNILLO
14	209315	4	RUOTA D.250X90	WHEEL	ROUE	RAD	RUEDA
15	206725	2	DISTANZIALE	SPACER	ENTRETOISE	DISTANZHÜLSE	DISTANCIADOR
16	408739	8	VITE M10X20 TE UNI 5737	SCREW	VIS	SCHRAUBE	TORNILLO
17	408670	2	VITE M8X20 TE UNI 5739	SCREW	VIS	SCHRAUBE	TORNILLO
18	409181	2	RONDELLA Ø8 GROWER	WASHER	RONDELLE	UNTERLAGSCHEIBE	ARANDELA
19	408711	8	VITE M10x25 TE UNI 5739	SCREW	VIS	SCHRAUBE	TORNILLO
20	409191	8	RONDELLA Ø10x21 UNI 6592	WASHER	RONDELLE	UNTERLAGSCHEIBE	ARANDELA
21	405458	2	RUOTA D.250X90	WHEEL	ROUE	RAD	RUEDA
22	202050	1	MOZZO RUOTE GEMELLATE	HUB	MOYEU	NABE	CUBO
23	206724	1	DISTANZIALE	SPACER	ENTRETOISE	DISTANZHÜLSE	DISTANCIADOR
24	203632	1	SUPPORTO RUOTE	SUPPORT	SUPPORT	HALTERUNG	SOPORTE
25	206723	1	PERNO	PIN	AXE	BOLZEN	PERNO
26	200142		KIT RUOTE GEMELLATE ANT.	FORE TWIN WHEELS KIT	ROUE ANT. JUIMEAU KIT	VOR. PAARIG RADER KIT	RUEDAS DELANT. GEMELAS KIT
27	200143		KIT RUOTE GEMELLATE POST.	REAR TWIN WHEELS KIT	ROUE ARR. JUIMEAU KIT	HINT. PAARIG RADER KIT	RUEDAS TRAS. GEMELAS KIT

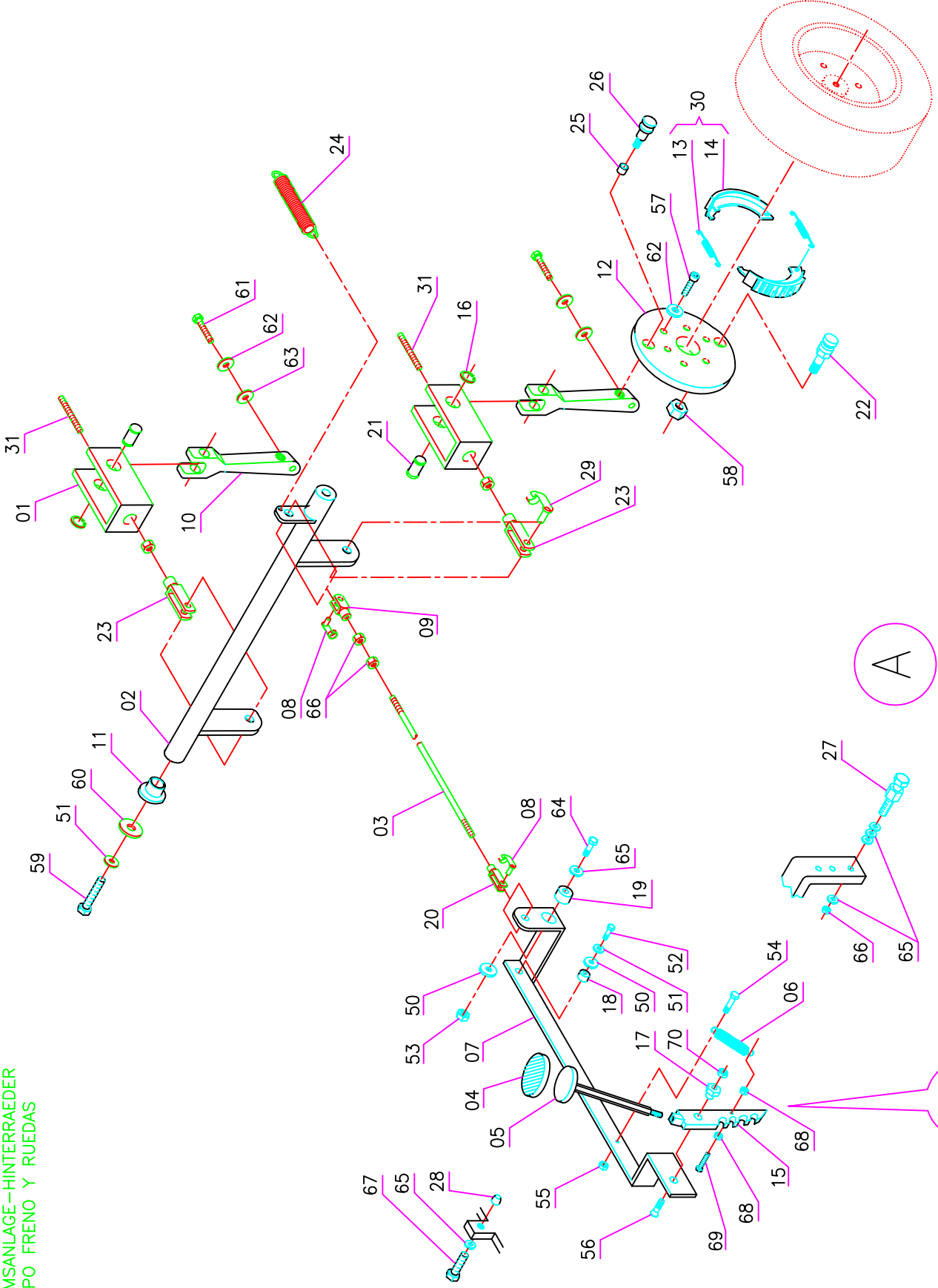

Pos.	Mod.	Codice	Q.tà	Denominazione	Description	Description	Benennung	Description
01		400776	2	FORCELLA FRENO	FORK	FOURCHETTE	GABELKOPF	HORQUILLA
02		400774	1	ALBERO COMANDO FRENO	SHAFT	ARBRE	WELLE	EJE
03		206706	1	TIRANTE	TIE ROD	TIGE	SPANNSTANGE	TIRANTE
04		400773	1	COPRIPEDALE	PEDAL COVER	GARNITURE PEDAL	PEDALGUMMI	CUBREPEDAL
05		206686	1	PEDALE	PEDAL	PEDALE	PEDAL	PEDAL
06		408113	1	MOLLA A TRAZIONE	SPRING	RESSORT	FEDER	RESORTE
07		400777	1	LEVA COMANDO FRENO	LEVER	LEVER	HEBEL	PALANCA
08		410464	2	PERNO PER FORCELLA M8	PIN	AXE	BOLZEN	PERNO
09		410456	1	FORCELLA M8	FORK	FOURCHETTE	GABELKOPF	HORQUILLA
10		410516	2	LEVA PER PERNO	LEVER	LEVER	STANGE	VARILLA
11		408040	2	BOCCOLA	BUSHING	BAGUE	BUCHSE	CASQUILLO
12		203627	2	PORTACEPPI	BRAKE DISK	DISQUE DE FREIN	BREMSSCHEIBE	DISCO DE FRENO
13		410531	4	MOLLA	SPRING	RESSORT	FEDER	RESORTE
14		410530	4	GANASCIA	BLOCK	MACHOIRE	BREMSKLOTZ	MORDAZA
15		203628	1	LEVA DI BLOCCO	LEVER	LEVER	HEBEL	PALANCA
16		408348	2	SEEGER E 12	SEEGER RING	SERRE CLIPS	SEEGERING	ANILLO SEEGER
17		408076	1	BOCCOLA FILETTATA M8	BUSHING	DOUILLE	BUCHSE	CASQUILLO
18		408018	1	BOCCOLA	BUSHING	BAGUE	BUCHSE	CASQUILLO
19		400775	1	DISTANZIALE	SPACER	ENTRETOISE	DISTANZHÜLSE	DISTANCIADOR
20		410457	1	FORCELLA M8 SX	FORK	FOURCHETTE	GABELKOPF	HORQUILLA
21		206705	2	PERNO FORCELLA	PIN	AXE	BOLZEN	PERNO
22		204377	2	PERNO GUIDA CEPPI	PIN	AXE	BOLZEN	PERNO
23		410455	2	FORCELLA M6	FORK	FOURCHETTE	GABELKOPF	HORQUILLA
24		202476	1	MOLLA TRAZIONE	SPRING	RESSORT	FEDER	RESORTE
25		408026	2	BOCCOLA LAMELLARE	BUSHING	BAGUE	BUCHSE	CASQUILLO
26		410532	2	PERNO OLIVA	PIN	AXE	BOLZEN	PERNO
27		206704	1	BLOCCO FRENO	BRAKE LOCK	BLOQUE DE FREIN	BREMSBLOCK	BLOQUE DE FRENO
28		409868	1	PIEDINO	CAP	BOUCHON	STOPFEN	TAPON
29		410463	2	PERNO	PIN	AXE	BOLZEN	PERNO
30		210550	1	COPIA CEPPI CON MOLLE	BLOCK-SPRING	MACHOIRE-RESSORT	BREMSKLOTZ-FEDER	MORDAZA-RESORTE
31		206703	2	ASTA COMANDO FRENO	ROD	TIGE	STANGE	VARILLA
50		409179		RONDELLA Ø9x24 UNI 6593	WASHER	RONDELLE	UNTERLAGSCHEIBE	ARANDELA
51		409181		RONDELLA Ø8 GROWER	WASHER	RONDELLE	UNTERLAGSCHEIBE	ARANDELA
52		408674		VITE M8x25 TE UNI 5739	SCREW	VIS	SCHRAUBE	TORNILLO
53		409085		DADO AUTOBL. M8 UNI 7474	LOCK NUT	ECROU AUTOBLOQUANT	STOPMUTTER	TUERCA AUTOBLOCCANTE
54		407649		VITE M5X40 TE UNI 5739	SCREW	VIS	SCHRAUBE	TORNILLO
55		409036		DADO M5 UNI 5587	NUT	ECROU	MUTTER	TUERCA
56		408981		VITE M8x22 TPSEI UNI 5933	SCREW	VIS	SCHRAUBE	TORNILLO
57		408802		VITE M6x40 TCEI UNI 5931	SCREW	VIS	SCHRAUBE	TORNILLO
58		409090		DADO AUTOBL. M10 UNI 7474	LOCK NUT	ECROU AUTOBLOQUANT	STOPMUTTER	TUERCA AUTOBLOCCANTE
59		408670		VITE M8X20 TE UNI 5739	SCREW	VIS	SCHRAUBE	TORNILLO
60		409180		RONDELLA Ø9x32 UNI 6593	WASHER	RONDELLE	UNTERLAGSCHEIBE	ARANDELA
61		407669		VITE M6x25 TE UNI 5739	SCREW	VIS	SCHRAUBE	TORNILLO
62		409164		RONDELLA GROWER Ø6	LOCK WASHER	RONDELLE FREIN	ZAHNSCHHEIBE	ARANDELA DENTADA
63		409156		RONDELLA Ø6x12 UNI 6592	WASHER	RONDELLE	UNTERLAGSCHEIBE	ARANDELA
64		408681		VITE M8x45 TE UNI 5739	SCREW	VIS	SCHRAUBE	TORNILLO
65		409175		RONDELLA Ø8x17 UNI 6592	WASHER	RONDELLE	UNTERLAGSCHEIBE	ARANDELA
66		409052		DADO M8 UNI 5587	NUT	ECROU	MUTTER	TUERCA
67		408670		VITE M8X20 TE UNI 5739	SCREW	VIS	SCHRAUBE	TORNILLO
68		409034		DADO M4 UNI 5587	NUT	ECROU	MUTTER	TUERCA
69		408635		VITE M4X25 TE UNI 5739	SCREW	VIS	SCHRAUBE	TORNILLO
70		409054		DADO M8x5 UNI 5589	NUT	ECROU	MUTTER	TUERCA

GRUPPO SERBATOIO SOLUZIONE  
 SOLUTION TANK ASSEMBLY  
 GROUPE DE RESERVOIR EAU PROPRE  
 GRUPPE LAUGENTANK  
 GRUPO TANQUE SOLUCION

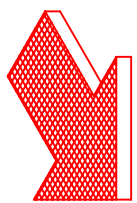
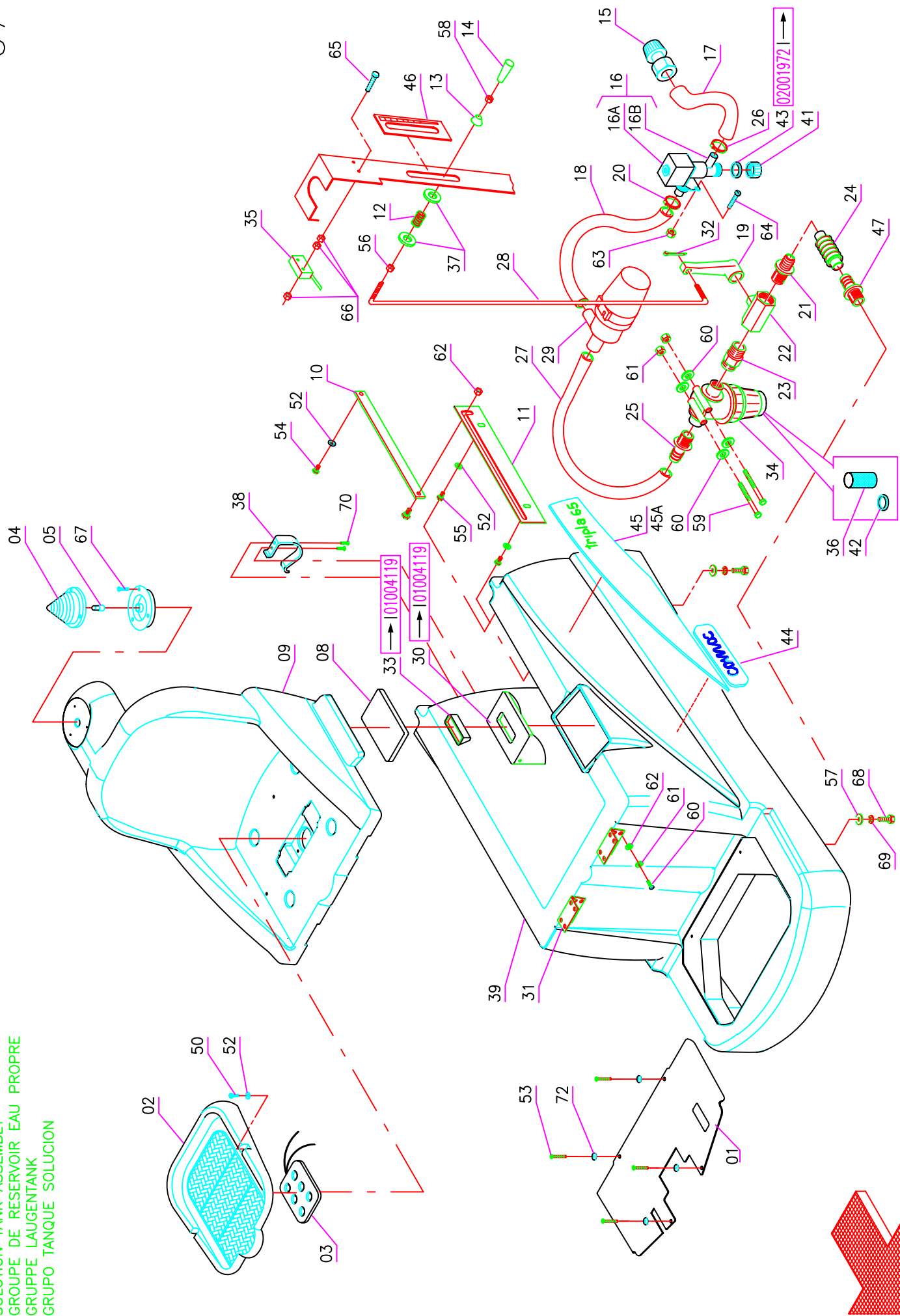



Pos. Mod.	Codice	Q.tà	Denominazione	Description	Description	Benennung	Description
01	400794	1	PEDANA	BOTTOM PLATE	REPOSE PIED	BODENBLECH	PLATAFORMA
02	400461	1	SEDILE	SEAT	SIEGE	SITZ	ASIENITO
03	409503	1	MICROINTERRUTTORE	MICROSWITCH	MICROINTERRUPTEUR	MIKROSCHALTER	MICROINTERRUPTOR
04	409796	1	LAMPPEGGIATORE	WINKING LIGHT	CLIGNOTEUR	BLINKANLAGE	DESTELLADOR
05	409529	1	LAMPADINA 48V 10W	ELECTRIC BULB	AMPOULE	GLÜHLAMPE	LAMPARA
08	409597	1	GUARNIZIONE SPORTELLO	GASKET	JOINT	DICHTUNG	JUNTA
09	400793	1	SUPPORTO SEDILE	SUPPORT	SUPPORT	HALTERUNG	SOPORTE
10	203639	1	PUNTELLO	PROP	LEVER	ABSTÜTZUNG	PUNAL
11	203640	1	STAFFA	SUPPORT	ATTAQUE	HALTERUNG	SOPORTE FIJADOR
12	408094	1	MOLLA	SPECIAL WASHER	RESSORT	FEDER	RESORTE
13	400250	1	RONDELLA SPECIALE	SPECIAL WASHER	RONDELLE SPECIALE	UNTERLAGSCHEIBE SPEZIAL	ARANDELA ESPECIAL
14	410264	1	MANOPOLA	KNOB	POIGNEE	HANDGRIFF	EMPUNADURA
15	410438	1	INNESTO RAPIDO	COUPLING	ENBRAYAGE	KUPPLUNG	ACOPLAMIENTO
16	407889	1	ELETTROVALVOLA 36V 1/2"	SOLENOID VALVE	ELECTROVANNE	MAGNETVENTIL	ELECTROVALVULA
16A	407869	1	BOBINA ELETTROV. 1/2"	SOLENOID VALVE BODY	BOBINE	SPULE	BOBINA
16B	407859	1	CORPO ELETTROV. 1/2"	SOLENOID VALVE BODY	CORPS DELECTROVANNE	KÖRPER MAGNETVENTIL	CUERPO ELECTROVALVULA
17	202141	2	TUBO Ø14x300 SPIRALATO	HOSE	TUYAU	SCHLAUCH	TUBO DE GOMA
18	209575	1	TUBO Ø12x310 SPIRALATO	HOSE	TUYAU	PIPE	TUBO
19	400199	1	LEVA RUBINETTO	COCK LEVER	LEVIER DE ROBINET	WASSERHAHNHEBEL	PALANCA DE GRIFO
20	410297	1	FASCETTA A VITE	CLAMP	COLLIER	BRIDE	ABRAZADERA
21	410376	1	PORTAGOMMA. DIRITTO 3/8" M	CONNECTOR	RACCORD	SCHLAUCHANSCHLUSS	EMPALME TUBO DE GOMA
22	410332	1	RUBINETTO 3/8 "	COCK	ROBINET	WASSERHAHN	GRIFO
23	410415	1	NIPLES 1/2-3/8 M.M.	NIPPLE	RACCORD	NIPPEL	BOQUILLA ROSCADA
24	400200	1	SOFFIETTO	BELLOWS	SOUFFLET	FALTENBALG	FUELLE
25	410389	1	PORTAGOMMA DIRITTO 1/2M D.13	CONNECTOR	RACCORD	SCHLAUCHANSCHLUSS	EMPALME TUBO DE GOMA
26	410293	1	FASCETTA	CLAMP	COLLIER	BRIDE	ABRAZADERA
27	209553	1	TUBO Ø14	HOSE	TUYAU	SCHLAUCH	TUBO DE GOMA
28	205632	1	ASTA RUBINETTO	ROD	TIGE	STANGE	VARILLA
29	407925	1	POMPA COMPLETA	PUMP ASSEMBLY	POMPE COMPLETE	PUMPE KOMPLETT	BOMBA COMPLETA
30	400785	1	SPORTELLO CARICO ACQUA	DOOR	PORTILLON	DECKEL	PORTEZUELA
31	400294	2	CERNIERA	HINGE	CHARNIERE	SCHARNIER	BISAGRA
32	409383	1	COPIGLIA Ø2x20 UNI 1336 INOX	SPLIT PIN	GOUPILLE	SPLINT	PASADOR DE ALETAS
33	400786	1	MANIGLIA SPORTELLO	HANDLE	MANCHE	HANDGRIFF	MANILLA
34	405409	1	FILTRO	FILTER	FILTRE	FILTER	FILTRO
35	409498	1	MICROINTERRUTTORE	MICROSWITCH	MICROINTERRUPTEUR	MIKROSCHALTER	MICROINTERRUPTOR
36	405410	1	CARTUCCIA FILTRO	FILTER CARTRIDGE	CARTOUCHE DE FILTRE	FILTEREINSATZ	CARTUCHO FILTRO
37	409166	2	RONDELLA Ø6x30x3 PVC	WASHER	RONDELLE	UNTERLAGSCHEIBE	ARANDELA
38	203595	1	AGGANCIO	COUPLER	ACCROCHAGE	ARRETERIUNG	ENGANCHE
39	408250	1	SERBATOIO SOLUZIONE	SOLUTION TANK	RESERVOIR EAU PROPRE	FRISCHWASSERTANK	TANQUE SOLUCION
41	410409	1	TAPPO	CAP	CAPUCHON	KAPPE	TAPON
42	409599	1	ANELLO OR	O-RING	ANNEAU TORIQUE	O-RING	JUNTA TORICA
43	408595	1	ANELLO OR 3056	O-RING	ANNEAU TORIQUE	O-RING	JUNTA TORICA
44	404988	2	ETIC. -COMAC-	DECAL	ETIQUETTE	SCHILD	ETIQUETA
45	404980	1	ETIC. LAT. SX	DECAL	ETIQUETTE	SCHILD	ETIQUETA
45A	404979	1	ETIC. LAT. DX	DECAL	ETIQUETTE	SCHILD	ETIQUETA
46	404898	1	ETIC. RUBINETTO	DECAL	ETIQUETTE	SCHILD	ETIQUETA
47	205020	1	PORTAGOMMA DIR. 1/2M SPEC.	CONNECTOR	RACCORD	SCHLAUCHANSCHLUSS	EMPALME TUBO DE GOMA
50	408861	1	VITE M6X25 TCTC UNI 7687	SCREW	VIS	SCHRAUBE	TORNILLO
51	409336	1	RONDELLA Ø6 DENTELLATA	LOCK WASHER	RONDELLE FREIN	ZAHNSCHEIBE	ARANDELA DENTADA
52	409161	1	RONDELLA Ø6x18 INOX UNI 6593	WASHER	RONDELLE	UNTERLAGSCHEIBE	ARANDELA
53	408967	1	VITE M6X20 TPSEI INOX UNI 5933	SCREW	VIS	SCHRAUBE	TORNILLO
54	407667	1	VITE M6X20 TE UNI 5739 INOX	SCREW	VIS	SCHRAUBE	TORNILLO
55	407664	1	VITE M6X16 TE INOX UNI 5739	SCREW	VIS	SCHRAUBE	TORNILLO
56	409036	1	DADO M5 UNI 5587	NUT	ECROU	MUTTER	TUERCA
57	409160	1	RONDELLA Ø6x18 UNI 6593	WASHER	RONDELLE	UNTERLAGSCHEIBE	ARANDELA
58	409038	1	DADO M5X3.5 UNI 5589	NUT	ECROU	MUTTER	TUERCA

GRUPPO SERBATOIO SOLUZIONE  
 SOLUTION TANK ASSEMBLY  
 GROUPE DE RESERVOIR EAU PROPRE  
 GRUPPE LAUGENTANK  
 GRUPO TANQUE SOLUCION

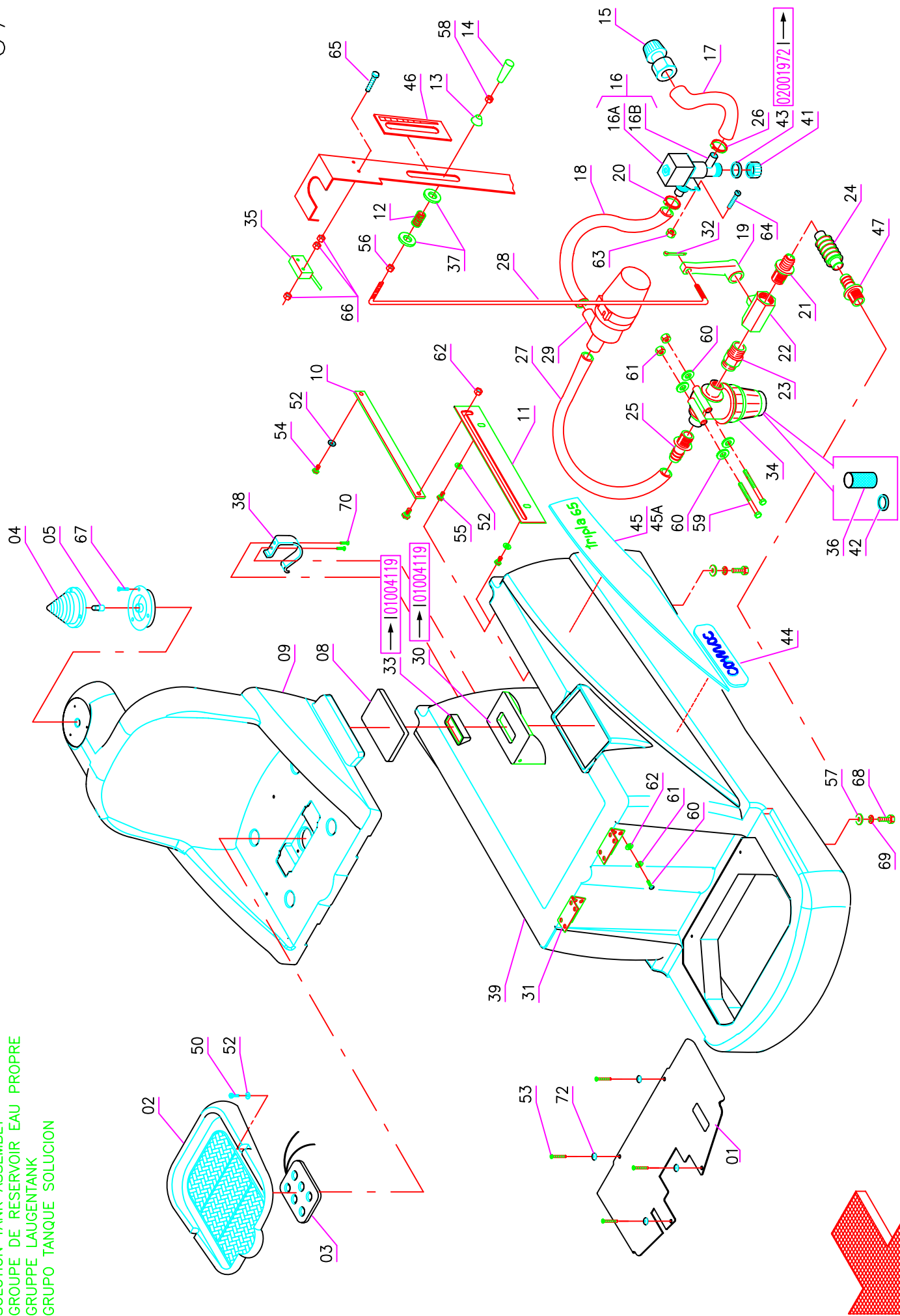

Pos. Mod.	Codice	Q.tà	Denominazione	Description	Description	Benennung	Description
59	408687		VITE M8X80 TE UNI 5737	SCREW	VIS	SCHRAUBE	TORNILLO
60	409175		RONDELLA Ø8x17 UNI 6592	WASHER	RONDELLE	UNTERLAGSCHEIBE	ARANDELA
61	409085		DADO AUTOBL. M8 UNI 7474	LOCK NUT	ECROU AUTOBLOQUANT	STOPMUTTER	TUERCA AUTOBLOCANTE
62	409179		RONDELLA Ø9x24 UNI 6593	WASHER	RONDELLE	UNTERLAGSCHEIBE	ARANDELA
63	409078		DADO AUTOBL. M4 UNI 7473	LOCK NUT	ECROU AUTOBLOQUANT	STOPMUTTER	TUERCA AUTOBLOCANTE
64	408846		VITE M4X16 TCTC UNI 7687	SCREW	VIS	SCHRAUBE	TORNILLO
65	408837		VITE M3X35 TCTC UNI 6107	SCREW	VIS	SCHRAUBE	TORNILLO
66	409033		DADO M3 OTTONE UNI 5587	NUT	ECROU	MUTTER	TUERCA
67	408954		VITE 4,2x16 AUTOF. RAPID FIX	SCREW	VIS	SCHRAUBE	TORNILLO
68	407666		VITE M6x20 TE UNI 5739	SCREW	VIS	SCHRAUBE	TORNILLO
69	409160		RONDELLA Ø6x18 UNI 6593	WASHER	RONDELLE	UNTERLAGSCHEIBE	ARANDELA
70	408883		VITE Ø4.8x13 UNI 6954 AUTOF.	SCREW	VIS	SCHRAUBE	TORNILLO
71	408876		VITE Ø3.9x13 UNI 6954 AUTOF.	SCREW	VIS	SCHRAUBE	TORNILLO
72	400250		ROSETTA SOTTOVITE	WASHER	RONDELLE	UNTERLAGSCHEIBE	ARANDELA

GRUPPO SERBATOIO RECUPERO  
 RECOVERY TANK ASSEMBLY  
 GROUPE DE RESERVOIR EAU SALE  
 GRUPPE SCHMUTZWASSERTANK  
 GRUPO TANQUE AGUA SUCIA

→ 105004778

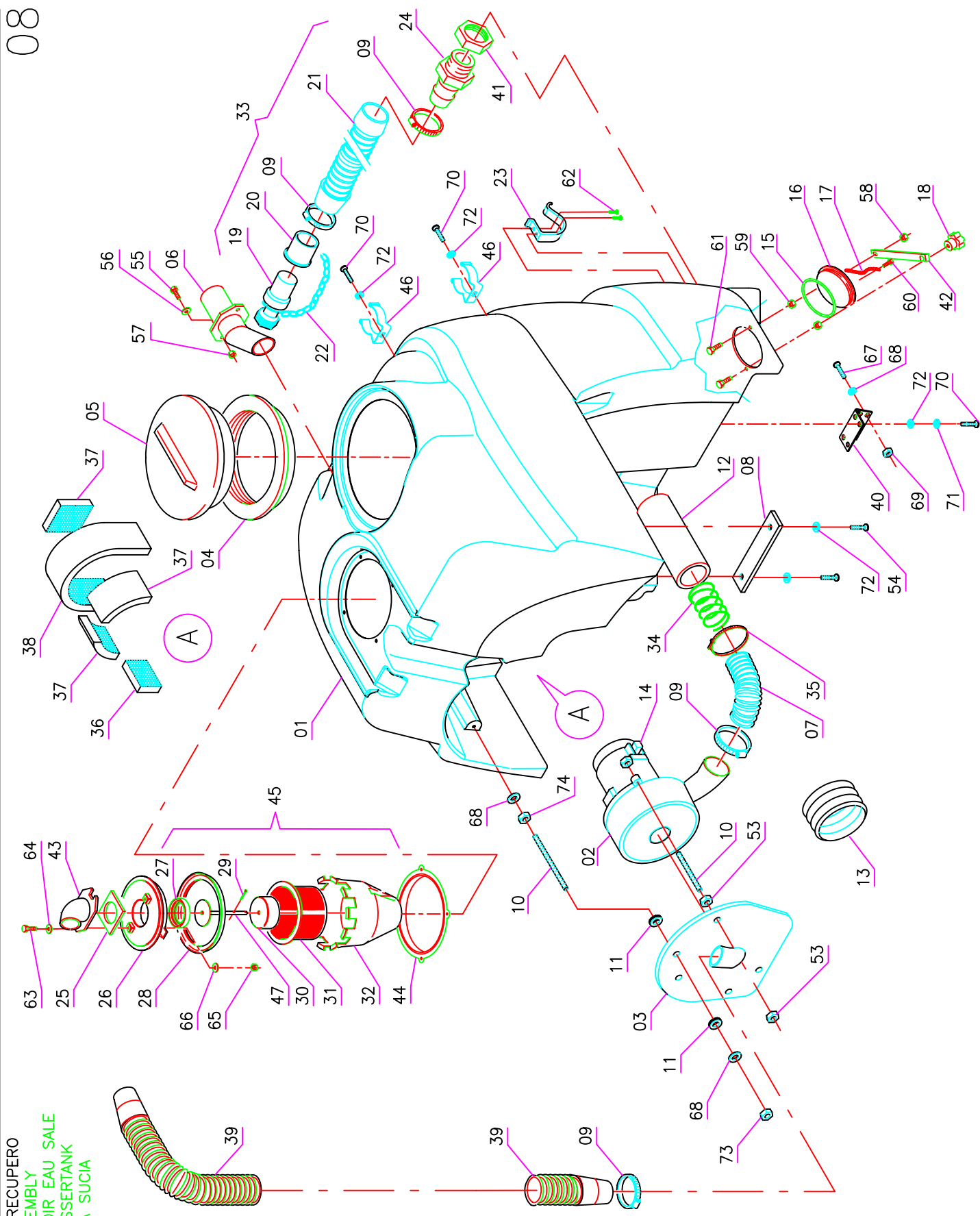

Pos.	Mod.	Codice	Q.tà	Denominazione	Description	Description	Benennung	Description
01		408252	1	SERBATOIO RECUPERO	RECOVERY TANK	RESERVOIR EAU SALE	SCHMUTZWASSERTANK	TANQUE AGUA SUCIA
02		407500	1	MOTORE ASPIRAZIONE	SUCTION MOTOR	MOTEUR D'ASPIRATION	SAUGMOTOR	MOTOR DE ASPIRACION
03		203645	1	PIASTRA ASPIRATORE	PLAQUE	PLAQUE	BEFESTIGUNGSAUFLAGE	PLACA
04		400494	1	ANELLO CON GUARNIZIONE	RING WITH GASKET	ANNEAU AVEC JOINT	RING MIT DICHTUNG	ANILLO CON JUNTA
05		400493	1	COPERCHIO	COVER	COUVERCLE	DECKEL	TAPA
06		400784	1	RACCORDO ASPIRAZIONE	FITTING	RACCORD	VERSCHRAUBUNG	RACOR
07		209481	1	TUBO SPIRALATO Ø50x200	PIPE	TUBE	ROHR	TUBO
08		206746	1	LAMA SOSTEGNO	BLADE	PLAQUE	PLATTE	LISTON
09		410295	4	FASCETTA A VITE	CLAMP	COLLIER	BRIDE	ABRAZADERA
10		205150	3	COLONNETTA	STUD BOLT	TIGE	GEWINDEBOLZEN	PRISIONERO
11		409810	3	PASSAFILO	FAIRLEAD	PASSE-CABLE	KABELDURCHGANG	GUIACABLE
12		202241	1	TUBO FONOASSORBENTE Ø50	DEADENING HOSE	TUYAU ISOLANT PHONIQUE	SCHALLSCHLUCKER	TUBO FONOAASSORBENTE
13		405936	1	CUFFIA	SHROUD	JOINT	LAGERRING	ANILLO
14		409409	2	SPAZZOLA MOTORE	CARBON BRUSH MOTOR	CHARBON MOTEUR	KOHLEBURSTE	ESCOBILLA MOTOR
15		408498	1	GUARNIZIONE OR 6375	O-RING	JOINT	O-RING	JUNTA ANULAR
16		400617	1	TAPPO	PLUG	BOUCHON	DECKEL	TAPON
17		203594	1	CATENA	CHAIN	CHAINE	KETTE	CADENA
18		410234	1	POMELLO VB40 M8	KNOB	POMMEAU	RENDELSCHRAUBE	POMO
19		203137	1	TAPPO SCARICO COMPLETO	PLUG EXHAUST PIPE	BOUCHON DE VIDANGE	ABLASSPFROPFEN	TAPON DE DESCARGA
20		405899	1	MANICOTTO	PIPE	TUBE	ROHR	TUBO
21		202193	1	TUBO	PIPE	TUBE	ROHR	TUBO
22		205827	1	CATENELLA PER TAPPO	CHAIN	CHAINE	KETTE	CADENA
23		203595	2	AGGANCIO	COUPLER	ACCROCHAGE	ARRETERUNG	ENGANCHE
24		410379	1	PORTAGOMMA DIRITTO 21M.-D.50	CONNECTOR	RACCORD	SCHLAUCHANSCHLUSS	EMPALME TUBO DE GOMA
25		405908	1	GUARNIZIONE	GASKET	JOINT	DICHTUNG	JUNTA
26		400541	1	TAPPO	COVER	COUVERCLE	DECKEL	TAPA
27		405910	1	GUARNIZIONE	GASKET	JOINT	DICHTUNG	JUNTA
28		405466	1	GUARNIZIONE	GASKET	JOINT	DICHTUNG	JUNTA
29		409383	2	COPIGLIA Ø2x20 UNI 1336 INOX	SPLIT PIN	GOUPILLE	SPLINT	PASADOR DE ALETAS
30		400540	1	GALLEGGIANTE	FLOAT	FLOTTEUR	SCHWIMMER	FLOTADOR
31		405395	1	FILTRO	FILTER	FILTRE	FILTER	FILTRO
32		400727	1	PROTEZIONE	PROTECTION	PROTECTION	ABDECKUNG	PROTECCION
33		209644	1	TUBO SCARICO COMPLETO	EXHAUST PIPE ASSEMBLY	FLEXIBLE DE VIDANGE COMPL.	ABWASSERSCHLAUCH KOMPL.	TUBO DE DESCARGA COMPLETO
34		202485	1	MOLLA	SPRING	RESSORT	FEDER	RESORTE
35		410276	1	FASCETTA 4.8x360	CLAMP	COLLIER	BRIDE	ABRAZADERA
36		405857	1	FONOASSORBENTE	DEADENING	ISOLANT PHONIQUE	SCHALLDICHTUNG	FONOASSORBENTE
37		405856	3	FONOASSORBENTE	DEADENING	ISOLANT PHONIQUE	SCHALLDICHTUNG	FONOASSORBENTE
38		405858	1	FONOASSORBENTE	DEADENING	ISOLANT PHONIQUE	SCHALLDICHTUNG	FONOASSORBENTE
39		209505	1	TUBO ASPIRAZIONE	PIPE	TUBE	ROHR	TUBO
40		400294	2	CERNIERA	HINGE	CHARNIERE	SCHARNIER	BISAGRA
41		410444	1	GHIERA 2"	RING NUT	EMBOUT	NUTMUTTER	TUERCA ANULAR
42		203593	1	LAMA	BLADE	PLAQUE	LEISTE	HOJA
43		400127	1	BOCCHETTA	OPENING	BUSE	ÖFFNUNG	BOQUILLA
44		400726	1	PORTAFILTRO	FILTER HOLDER	PORTE-FILTRE	FILTERTRÄGER	PORTAFILTRO
45		200195	1	ASSEMBLE FILTRO-GALLEGGIANTE	FLOAT ASSEMBLY	FLOTTEUR COMPLET	SCHWIMMER KOMPLETT	FLOTADOR COMPLETO
46		408126	2	CLIP FISSATUBO	CLIP HOSE FIXING	CLIP FIXAGE DE TUYAU	KLIPP SCHLAUCHBEFESTIGUNG	CLIP FIJACION DE TUBO
47		400537	1	ASTA	ROD	TIGE	STANGE	VARILLA
51		409152	1	ROSETTA PIANA Ø5	WASHER	RONDELLE	SCHIBE	ARANDELA
52		409334	1	RONDELLA DENTELLATA Ø5	LOCK WASHER	RONDELLE FREIN	ZAHNSCHIBE	ARANDELA DENTADA
53		409039	1	DADO M6 UNI 5587	NUT	EGROU	MUTTER	TUERCA
54		408506	1	VITE 5.2x20 AUTOFIL.	SCREW	VIS	SCHRAUBE	TORNILLO
55		407667	1	VITE M6x20 TE UNI 5739 INOX	SCREW	VIS	SCHRAUBE	TORNILLO
56		409161	1	RONDELLA Ø 6x18 INOX UNI 6593	WASHER	RONDELLE	UNTERLAGSCHEIBE	ARANDELA
57		409083	1	DADO AUT. M6 INOX UNI 7474	LOCK NUT	EGROU AUTOBLOQUANT	STOPMUTTER	TUERCA AUTOBLOCANTE
58		409088	1	DADO AUTOBL. M8 INOX UNI 7473	LOCK NUT	EGROU AUTOBLOQUANT	STOPMUTTER	TUERCA AUTOBLOCANTE
59		409051	1	DADO M8 INOX UNI 5587	NUT	EGROU	MUTTER	TUERCA

GRUPPO SERBATOIO RECUPERO  
 RECOVERY TANK ASSEMBLY  
 GROUPE DE RESERVOIR EAU SALE  
 GRUPPE SCHMUTZWASSERTANK  
 GRUPO TANQUE AGUA SUCIA

→ 105004778

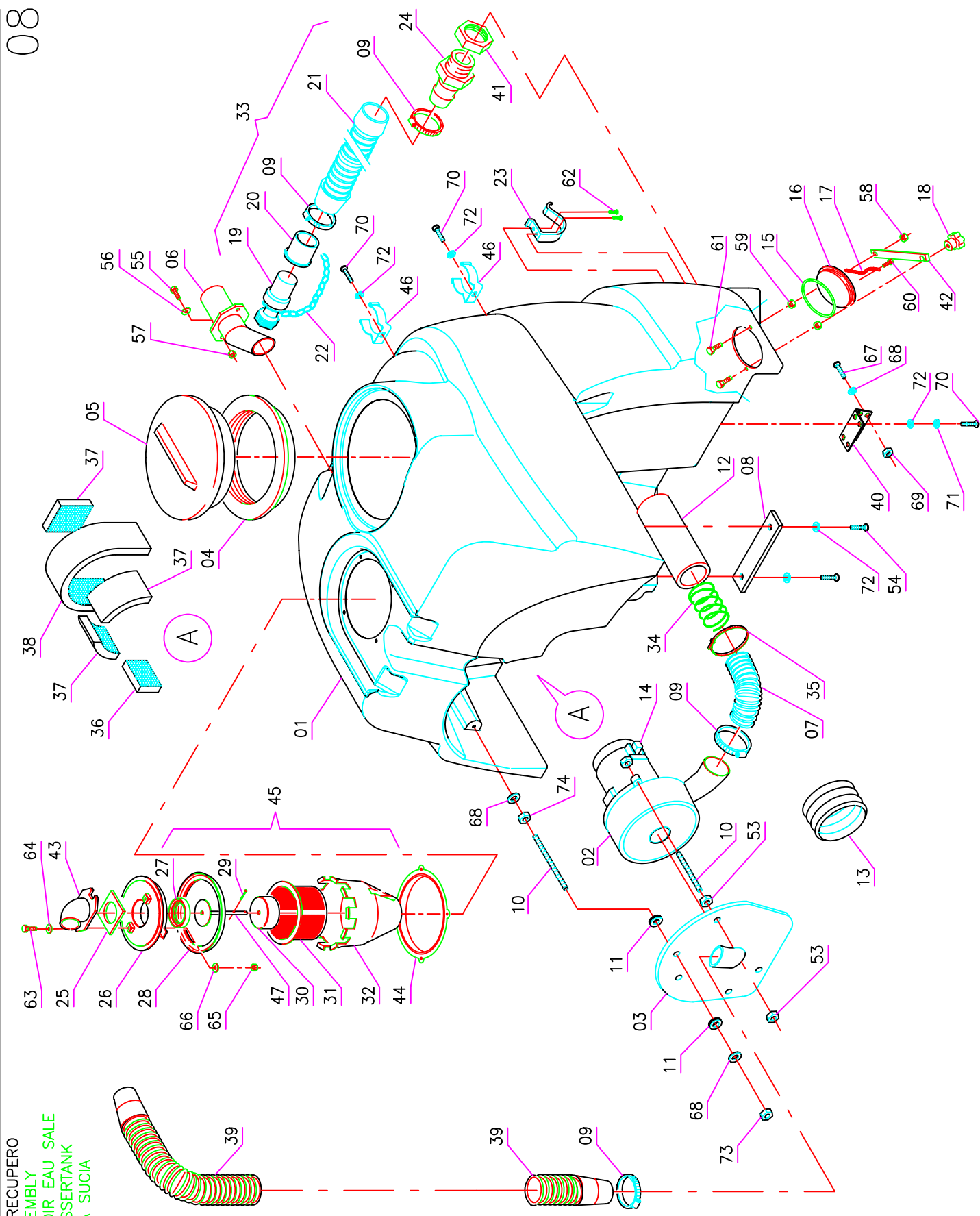

Pos.	Mod.	Codice	Q.tà	Denominazione	Description	Description	Benennung	Description
60		408871		VITE Ø3,9x13 AUTOF. TCTC	SCREW	VIS	SCHRAUBE	TORNILLO
61		408916		GRANO M8x60 E.I. UNI 5923	DOWEL	VIS	MADENSCHRAUBE	TORNILLO
62		408883		VITE Ø4,8x13 UNI 6954 AUTOF.	SCREW	VIS	SCHRAUBE	TORNILLO
63		408636		VITE M4x25 TE UNI 5739 INOX	SCREW	VIS	SCHRAUBE	TORNILLO
64		409153		RONDELLA Ø5x20 UNI 6593	WASHER	RONDELLE	UNTERLAGSCHEIBE	ARANDELA
65		409035		DADO M4 INOX UNI 5587	NUT	ECROU	MUTTER	TUERCA
66		409143		RONDELLA Ø4x9 UNI 6952 INOX	WASHER	RONDELLE	UNTERLAGSCHEIBE	ARANDELA
67		407663		VITE M6X16 TE UNI 5739	SCREW	VIS	SCHRAUBE	TORNILLO
68		409156		RONDELLA Ø6x12 UNI 6592	WASHER	RONDELLE	UNTERLAGSCHEIBE	ARANDELA
69		409082		DADO M6 AUTOBL. UNI 7474	LOCK NUT	ECROU AUTOBLOQUANT	STOPMUTTER	TUERCA AUTOBLOCCANTE
70		407644		VITE M5x12 TE UNI 5739	SCREW	VIS	SCHRAUBE	TORNILLO
71		409154		ROSETTA GROWER Ø5	WASHER	RONDELLE	SCHHEIBE	ARANDELA
72		409150		RONDELLA Ø5X11 UNI 6592	WASHER	RONDELLE	UNTERLAGSCHEIBE	ARANDELA
73		409080		DADO AUTOBL. M5 UNI 7473	LOCK NUT	ECROU AUTOBLOQUANT	STOPMUTTER	TUERCA AUTOBLOCCANTE
74		409036		DADO M5 UNI 5587	NUT	ECROU	MUTTER	TUERCA

GRUPPO SERBATOIO RECUPERO  
RECOVERY TANK ASSEMBLY  
GROUPE DE RESERVOIR EAU SALE  
GRUPPE SCHMUTZWASSERTANK  
GRUPO TANQUE AGUA SUCIA

05004779 | →

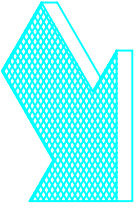
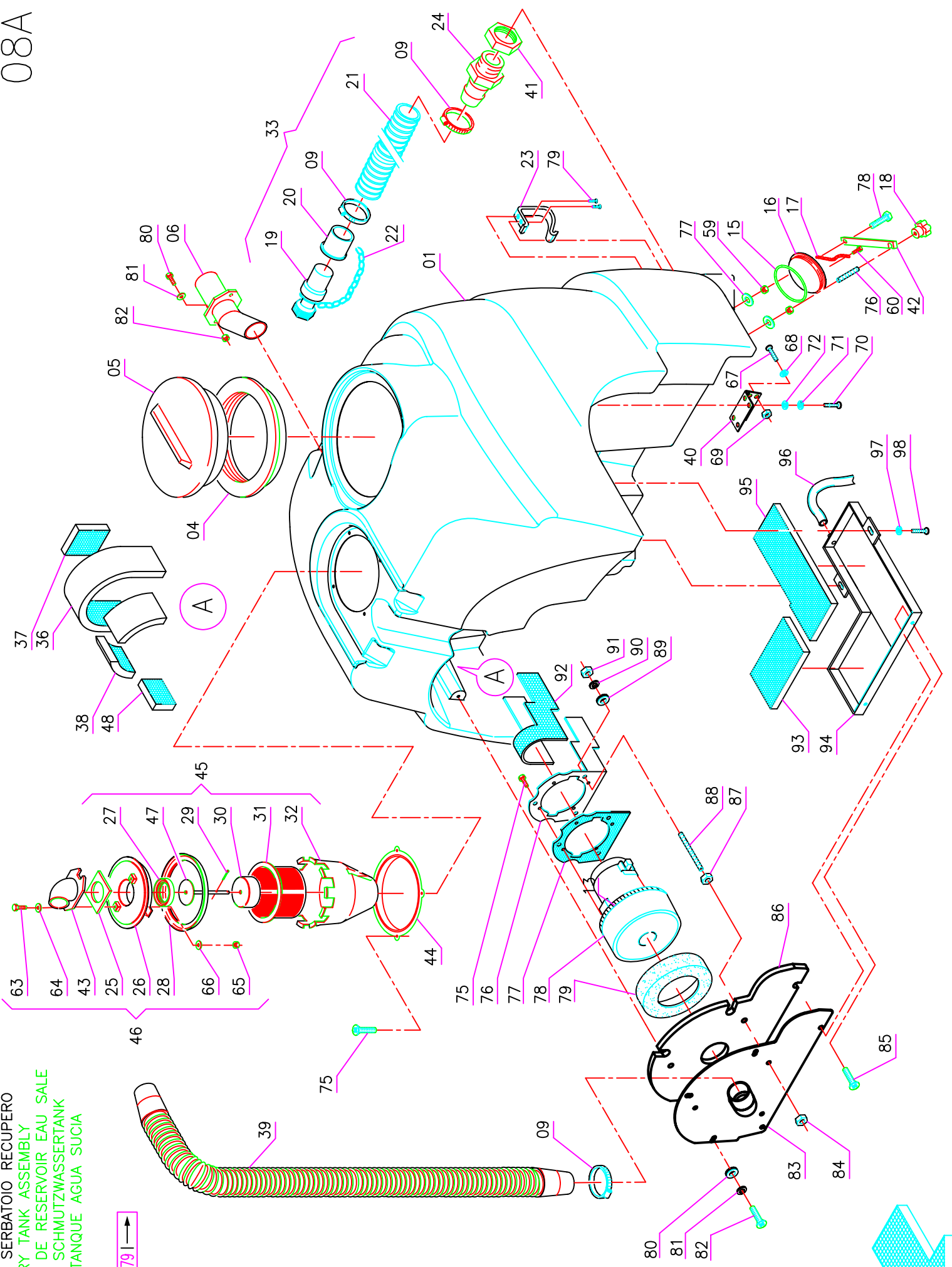



Pos.	Mod.	Codice	Q.tà	Denominazione	Description	Description	Benennung	Description
01		408252	1	SERBATOIO RECUPERO	RECOVERY TANK	RESERVOIR EAU SALE	SCHMUTZWASSERTANK	TANQUE AGUA SUCIA
02		407500	1	MOTORE ASPIRAZIONE	SUCTION MOTOR	MOTEUR D'ASPIRATION	SAUGMOTOR	MOTOR DE ASPIRACION
03		203645	1	PIASTRA ASPIRATORE	PLAQUE	PLAQUE	BEFESTIGUNGSAUFLAGE	PLACA
04		400494	1	ANELLO CON GUARNIZIONE	RING WITH GASKET	ANNEAU AVEC JOINT	RING MIT DICHTUNG	ANILLO CON JUNTA
05		400493	1	COPERCHIO	COVER	COUVERCLE	DECKEL	TAPA
06		400784	1	RACCORDO ASPIRAZIONE	FITTING	RACCORD	VERSCHRAUBUNG	RACOR
07		209481	1	TUBO SPIRALATO Ø50x200	PIPE	TUBE	ROHR	TUBO
08		206746	1	LAMA SOSTEGNO	BLADE	PLAQUE	LISTON	LISTON
09		410295	4	FASCETTA A VITE	CLAMP	COLLIER	BRIDE	ABRAZADERA
10		205150	3	COLONNETTA	STUD BOLT	TIGE	GEWINDEBOLZEN	PRISIONERO
11		409810	3	PASSAFILO	FAIRLEAD	PASSE-CABLE	KABELDURCHGANG	GUIACABLE
12		202241	1	TUBO FONOASSORBENTE Ø50	DEADENING HOSE	TUYAU ISOLANT PHONIQUE	SCHALLSCHLUCKER	TUBO FONOAASSORBENTE
13		405936	1	CUFFIA	SHROUD	JOINT	LAGERRING	ANILLO
14		409409	2	SPAZZOLA MOTORE	CARBON BRUSH MOTOR	CHARBON MOTEUR	KOHLEBURSTE	ESCOBILLA MOTOR
15		408498	1	GUARNIZIONE OR 6375	O-RING	JOINT	O-RING	JUNTA ANULAR
16		400617	1	TAPPO	PLUG	BOUCHON	DECKEL	TAPON
17		203594	1	CATENA	CHAIN	CHAINE	KETTE	CADENA
18		410234	1	POMELLO VB40 M8	KNOB	POMMEAU	RENDELSCHRAUBE	POMO
19		203137	1	TAPPO SCARICO COMPLETO	PLUG EXHAUST PIPE	BOUCHON DE VIDANGE	ABLASSPFROFFEN	TAPON DE DESCARGA
20		405899	1	MANICOTTO	PIPE	TUBE	ROHR	TUBO
21		202193	1	TUBO	PIPE	TUBE	ROHR	TUBO
22		205827	1	CATENELLA PER TAPPO	CHAIN	CHAINE	KETTE	CADENA
23		203595	2	AGGANCIO	COUPLER	ACCROCHAGE	ARRETERUNG	ENGANCHE
24		410379	1	PORTAGOMMA DIRITTO 21M.-D.50	CONNECTOR	RACCORD	SCHLAUCHANSCHLUSS	EMPALME TUBO DE GOMA
25		405908	1	GUARNIZIONE	GASKET	JOINT	DICHTUNG	JUNTA
26		400541	1	TAPPO	COVER	COUVERCLE	DECKEL	TAPA
27		405910	1	GUARNIZIONE	GASKET	JOINT	DICHTUNG	JUNTA
28		405466	1	GUARNIZIONE	GASKET	JOINT	DICHTUNG	JUNTA
29		409383	2	COPIGLIA Ø2x20 UNI 1336 INOX	SPLIT PIN	GOUPILLE	SPLINT	PASADOR DE ALETAS
30		400540	1	GALLEGGIANTE	FLOAT	FLOTTEUR	SCHWIMMER	FLOTADOR
31		405395	1	FILTRO	FILTER	FILTRE	FILTER	FILTRO
32		400727	1	PROTEZIONE	PROTECTION	PROTECTION	ABDECKUNG	PROTECCION
33		209644	1	TUBO SCARICO COMPLETO	EXHAUST PIPE ASSEMBLY	FLEXIBLE DE VIDANGE COMPL.	ABWASSERSCHLAUCH KOMPL.	TUBO DE DESCARGA COMPLETO
34		202485	1	MOLLA	SPRING	RESSORT	FEDER	RESORTE
35		410276	1	FASCETTA 4.8x360	CLAMP	COLLIER	BRIDE	ABRAZADERA
36		405857	1	FONOAASSORBENTE	DEADENING	ISOLANT PHONIQUE	SCHALLDICHTUNG	FONOAASSORBENTE
37		405856	3	FONOAASSORBENTE	DEADENING	ISOLANT PHONIQUE	SCHALLDICHTUNG	FONOAASSORBENTE
38		405858	1	FONOAASSORBENTE	DEADENING	ISOLANT PHONIQUE	SCHALLDICHTUNG	FONOAASSORBENTE
39		209505	1	TUBO ASPIRAZIONE	PIPE	TUBE	ROHR	TUBO
40		400294	2	CERNIERA	HINGE	CHARNIERE	SCHARNIER	BISAGRA
41		410444	1	GHIERA 2"	RING NUT	EMBOUT	NUTMUTTER	TUERCA ANULAR
42		203593	1	LAMA	BLADE	PLAQUE	LEISTE	HOJA
43		400127	1	BOCCHETTA	OPENING	BUSE	ÖFFNUNG	BOQUILLA
44		400726	1	PORTAFILTRO	FILTER HOLDER	PORTE-FILTRE	FILTERTRÄGER	PORTAFILTRO
45		200195	1	ASSIEME FILTRO-GALLEGGIANTE	FLOAT ASSEMBLY	FLOTTEUR COMPLET	SCHWIMMER KOMPLETT	FLOTADOR COMPLETO
46		408126	2	CLIP FISSATUBO	CLIP HOSE FIXING	CLIP FIXAGE DE TUYAU	KLIPP SCHLAUCHBEFESTIGUNG	CLIP FIJACION DE TUBO
47		400537	1	ASTA	ROD	TIGE	STANGE	VARILLA
51		409152	1	ROSETTA PIANA Ø5	WASHER	RONDELLE	SCHHEIBE	ARANDELA
52		409334	1	RONDELLA DENITELLATA Ø5	LOCK WASHER	RONDELLE FREIN	ZAHNSCHEIBE	ARANDELA DENTADA
53		409039	1	DADO M6 UNI 5587	NUT	EGROU	MUTTER	TUERCA
54		408506	1	VITE 5.2x20 AUTOFIL.	SCREW	VIS	SCHRAUBE	TORNILLO
55		407667	1	VITE M6x20 TE UNI 5739 INOX	SCREW	VIS	SCHRAUBE	TORNILLO
56		409161	1	RONDELLA Ø 6x18 INOX UNI 6593	WASHER	RONDELLE	UNTERLAGSCHEIBE	ARANDELA
57		409083	1	DADO AUT. M6 INOX UNI 7474	LOCK NUT	EGROU AUTOBLOQUANT	STOPMUTTER	TUERCA AUTOBLOCANTE
58		409088	1	DADO AUTOBL. M8 INOX UNI 7473	LOCK NUT	EGROU AUTOBLOQUANT	STOPMUTTER	TUERCA AUTOBLOCANTE
59		409051	1	DADO M8 INOX UNI 5587	NUT	EGROU	MUTTER	TUERCA

GRUPPO SERBATOIO RECUPERO  
RECOVERY TANK ASSEMBLY  
GROUPE DE RESERVOIR EAU SALE  
GRUPPE SCHMUTZWASSERTANK  
GRUPO TANQUE AGUA SUCIA

05004779 | →

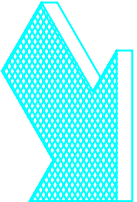
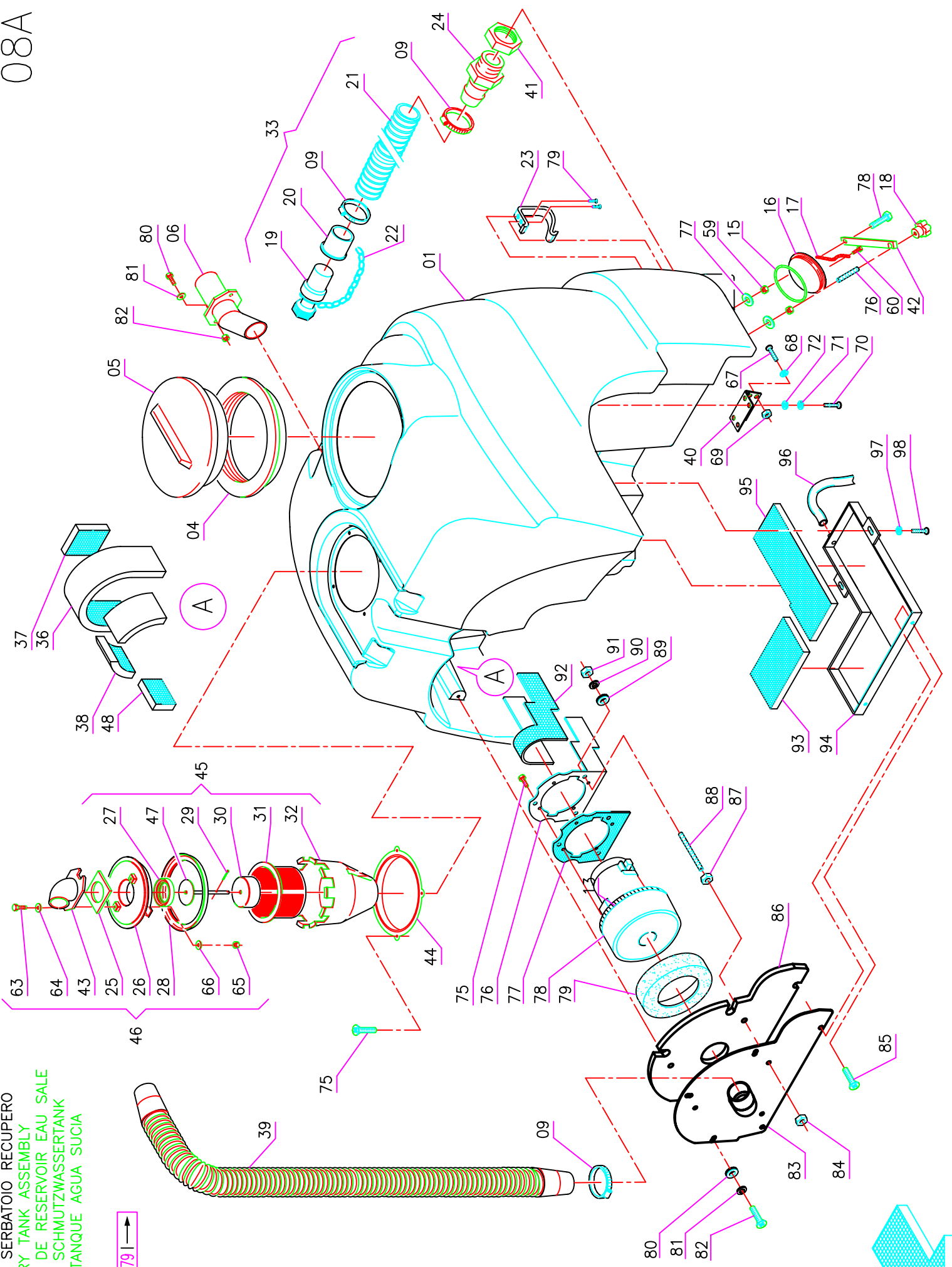

Pos. Mod.	Codice	Q.tà	Denominazione	Description	Description	Benennung	Description
60	408871		VITE Ø3,9x13 AUTOF. TCTC	SCREW	VIS	SCHRAUBE	TORNILLO
61	408916		GRANO M8x60 E.I. UNI 5923	DOWEL	VIS	MADENSCHRAUBE	TORNILLO
62	408883		VITE Ø4,8x13 UNI 6954 AUTOF.	SCREW	VIS	SCHRAUBE	TORNILLO
63	408636		VITE M4x25 TE UNI 5739 INOX	SCREW	VIS	SCHRAUBE	TORNILLO
64	409153		RONDELLA Ø5x20 UNI 6593	WASHER	RONDELLE	UNTERLAGSCHEIBE	ARANDELA
65	409035		DADO M4 INOX UNI 5587	NUT	ECROU	MUTTER	TUERCA
66	409143		RONDELLA Ø4x9 UNI 6952 INOX	WASHER	RONDELLE	UNTERLAGSCHEIBE	ARANDELA
67	407663		VITE M6x16 TE UNI 5739	SCREW	VIS	SCHRAUBE	TORNILLO
68	409156		RONDELLA Ø6x12 UNI 6592	WASHER	RONDELLE	UNTERLAGSCHEIBE	ARANDELA
69	409082		DADO M6 AUTOBL. UNI 7474	LOCK NUT	ECROU AUTOBLOQUANT	STOPMUTTER	TUERCA AUTOBLOCANTE
70	407644		VITE M5x12 TE UNI 5739	SCREW	VIS	SCHRAUBE	TORNILLO
71	409154		ROSETTA GROWER Ø5	WASHER	RONDELLE	SCHHEIBE	ARANDELA
72	409150		RONDELLA Ø5x11 UNI 6592	WASHER	RONDELLE	UNTERLAGSCHEIBE	ARANDELA
73	409080		DADO AUTOBL. M5 UNI 7473	LOCK NUT	ECROU AUTOBLOQUANT	STOPMUTTER	TUERCA AUTOBLOCANTE
74	409036		DADO M5 UNI 5587	NUT	ECROU	MUTTER	TUERCA
75	408503		VITE AUTOF. 4,8x13 INOX UNI 6954	SCREW	VIS	SCHRAUBE	TORNILLO
76	205638	1	CONTROPIASTRA MOTORE	PLAQUE	PLAQUE	BEFESTIGUNGSAUFLAGE	PLACA
77	405882	1	FONOASSORBENTE	DEADENING	ISOLANT PHONIQUE	SCHALLDICHTUNG	FONOASSORBENTE
78	209819	1	MOTORE ASPIRAZIONE 36V	SUCTION MOTOR	MOTEUR D'ASPIRATION	SAUGMOTOR	MOTOR DE ASPIRACION
79	405936	1	CUFFIA MOTORE ASPIRAZIONE	SHROUD	JOINT	LAGERRING	ANILLO
80	409810		PASSACAPO	FAIRLEAD	PASSE-CABLE	KABELDURCHGANG	GUIACABLE
81	409150		RONDELLA Ø5 UNI 6592	WASHER	RONDELLE	UNTERLAGSCHEIBE	ARANDELA
82	408854		VITE M5X16 TCTC UNI 7687	SCREW	VIS	SCHRAUBE	TORNILLO
83	206747		PIASTRA MOT.ASPIRAZIONE	PLAQUE	PLAQUE	SCHRAUBE	PLACA
84	409040		DADO M6 ZNT UNI 5588	NUT	ECROU	MUTTER	TUERCA
85	408853		VITE M5X16 TCTC UNI 7687 INOX	SCREW	VIS	SCHRAUBE	TORNILLO
86	405881		FONOAS. PIASTRA MOTORE	DEADENING	ISOLANT PHONIQUE	SCHALLDICHTUNG	FONOASSORBENTE
87	409040		DADO M6 ZNT UNI 5588	NUT	ECROU	MUTTER	TUERCA
88	205150		COLONNETTA	STUD BOLT	TIGE	GEWINDEBOLZEN	PRISIONERO
89	409810		PASSACAPO	FAIRLEAD	PASSE-CABLE	KABELDURCHGANG	GUIACABLE
90	409160		ROSETTA Ø 6 UNI 6593	WASHER	RONDELLE	UNTERLAGSCHEIBE	ARANDELA
91	409082		DADO M6 AUTOBL. UNI 7474	LOCK NUT	ECROU AUTOBLOQUANT	STOPMUTTER	TUERCA AUTOBLOCANTE
92	405883		FONOASSORBENTE	DEADENING	ISOLANT PHONIQUE	SCHALLDICHTUNG	FONOASSORBENTE
93	405880		FONOASSORBENTE	DEADENING	ISOLANT PHONIQUE	SCHALLDICHTUNG	FONOASSORBENTE
94	205637		VASCETTA	DISTRIBUTOR	DISTRIBUTEUR	VERTEILER	DISTRIBUIDOR
95	405879		FONOASSORBENTE	DEADENING	ISOLANT PHONIQUE	SCHALLDICHTUNG	FONOASSORBENTE
96	202212		TUBO VITREO	PIPE	TUBE	ROHR	TUBO
97	409149		ROSETTA M5 UNI 6592 INOX	WASHER	RONDELLE	SCHHEIBE	ARANDELA
98	409040		DADO M6 ZNT UNI 5588	NUT	ECROU	MUTTER	TUERCA

GRUPPO TERGIPAVIMENTO (LAVANTE)  
 SQUEEGEE ASSEMBLY  
 ENSEMBLE DE SUCEUR  
 SAUGFLUSSGRUPPE  
 GRUPO LIMPIAPAVIMENTOS

9A

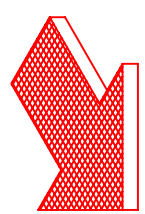
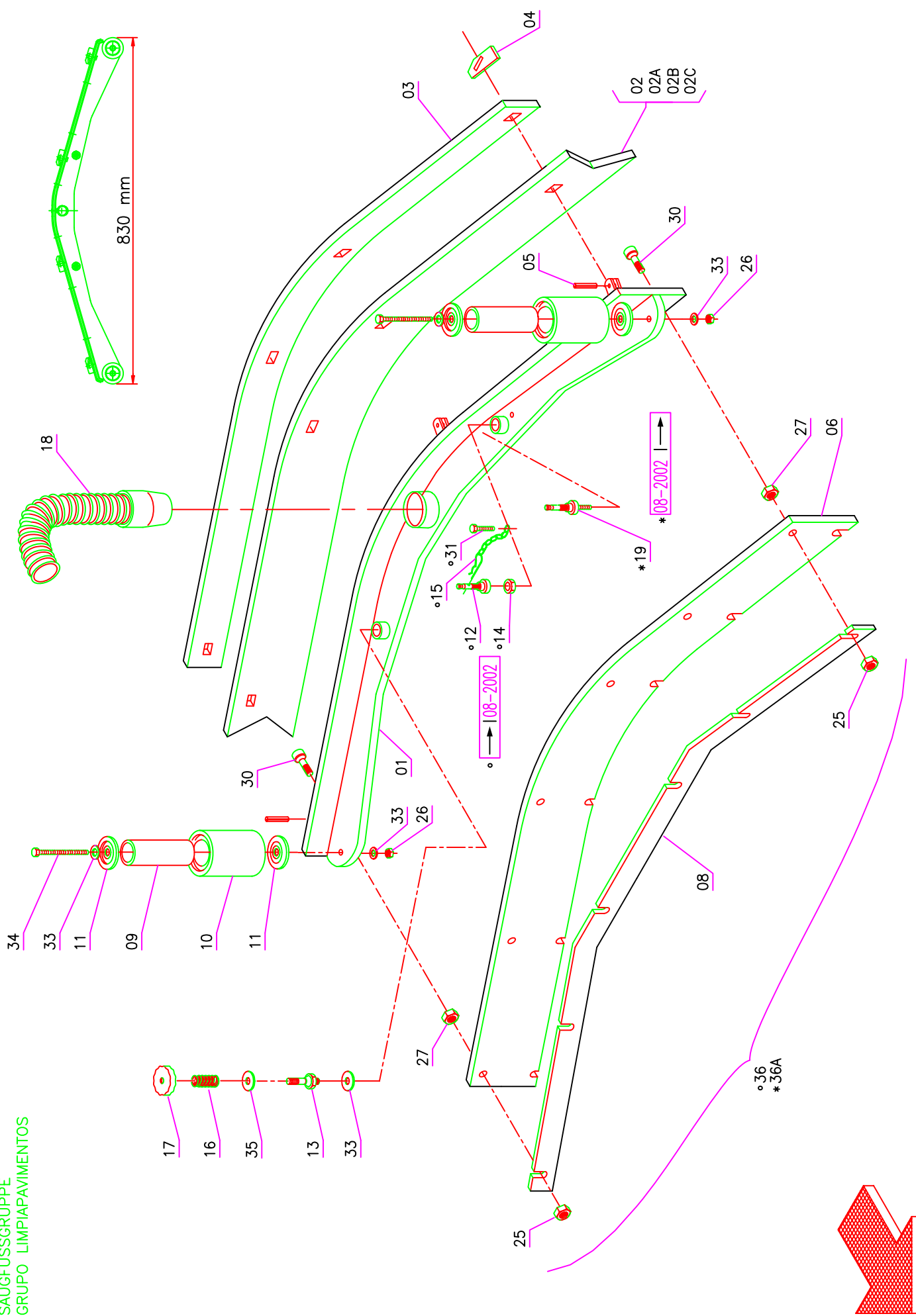

Pos. Mod.	Codice	Q.tà	Denominazione	Description	Description	Benennung	Description
01	210345	1	CORPO TERGIPAVIMENTO	SQUEEGEE BODY	CORPS DE SUCEUR	SAUGFUSSKÖRPER	CUERPO LIMPIAPAVIMENTOS
02	406176	1	GOMMA POSTERIORE 33 SH	REAR RUBBER	BAVETTE ARRIERE	HINTERER SAUGGUMMI	GOMA TRASERA
02A	406177	1	GOMMA POSTERIORE 40 SH	REAR RUBBER 40	BAVETTE ARRIERE	HINT. SAUGGUMMI	GOMA TRASERA
02B	406178	1	GOMMA POSTERIORE ANTIOILIO	REAR RUBBER OIL-RESISTANT	BAVETTE ARRIERE ANTI-HUILE	SAUGGUMMI OELBESTAENDIG	GOMA TRASERA ANTI-ACEITE
02C	406181	1	GOMMA POST. POLIURETANO 40 SH	REAR RUBBER POLYURETHANE	BAVETTE ARR. POLYURETHANE	SAUGGUMMI POLYURETHAN	GOMA TRASERA POLIURETANO
03	210038	1	LAMA PREMIGOMMA POSTERIORE	BLADE	PLAQUETTE	LEISTE	LISTON
04	400260	4	PIASTRINA PREMIGOMMA	PLAQUE	PLAQUETTE	BEFESTIGUNGSAUFLAGE	PLAQUETA
05	409374	4	SPINA ELASTICA Ø5x14 UNI 6873	SPRING PIN	FOURCHETTE	SPANNSTIFT	PASADOR
06	209706	1	GOMMA ANTERIORE	FRONT RUBBER	BAVETTE AVANT	VORDERER SAUGGUMMI	GOMA DELANTERA
08	210037	1	LAMA PREMIGOMMA ANTERIORE	BLADE	PLAQUETTE	LEISTE	LISTON
09	203353	2	PERNO GUIDA RUOTA	PIN	AXE	BOLZEN	PERNO
10	405711	2	RUOTA PARACOLPI Ø 80	WHEEL	ROUE	RAD	
11	203352	4	RONDELLA SPECIALE	SPECIAL WASHER	RONDELLE SPECIALE	UNTERLAGSCHEIBE SPEZIAL	ARANDELA ESPECIAL
12	204975	1	COLONNETTA	STUD BOLT	TIGE	GEWINDEBOLZEN	PRISIONERO
13	200016	1	COLONNETTA SGANCIO	STUD BOLT	TIGE	GEWINDEBOLZEN	PRISIONERO
14	204367	1	DADO SPECIALE	SPECIAL NUT	ECROU SPECIAL	SPEZIALMUTTER	TUERCA ESPECIAL
15	203273	1	CATENELLA	CHAIN	CHAINE	KETTE	CADENA
16	408098	1	MOLLA A COMPRESSIONE	SPRING	RESSORT	FEDER	RESORTE
17	400112	1	VOLANTINO	HANDWHEEL	VOLANT	HANDGRIFF	RUEDA DE MANIOBRA
18	202175	1	TUBO	PIPE	TUBE	ROHR	TUBO
19	200015	1	COLONNETTA	STUD BOLT	TIGE	GEWINDEBOLZEN	PRISIONERO
25	409083	1	DADO AUT. M6 INOX UNI 7474	LOCK NUT	ECROU AUTOBLOQUANT	STOPMUTTER	TUERCA AUTOBLOCANTE
26	409090	1	DADO AUTOBL. M10 UNI 7474	LOCK NUT	ECROU AUTOBLOQUANT	STOPMUTTER	TUERCA AUTOBLOCANTE
27	409043	1	DADO M6 INOX UNI 5588	NUT	ECROU	MUTTER	TUERCA
30	408967	1	VITE M6x20 TPSEI INOX UNI 5933	SCREW	VIS	SCHRAUBE	TORNILLO
31	408853	1	VITE M5x16 TCTC UNI 7687 INOX	SCREW	VIS	SCHRAUBE	TORNILLO
33	409191	1	RONDELLA Ø10x21 UNI 6592	WASHER	RONDELLE	UNTERLAGSCHEIBE	ARANDELA
34	408736	1	VITE M10x110 TE UNI 5737	SCREW	VIS	SCHRAUBE	TORNILLO
35	409179	1	RONDELLA Ø9x24 UNI 6593	WASHER	RONDELLE	UNTERLAGSCHEIBE	ARANDELA
36	200261	1	ASSIEME TERGIPAVIMENTO	SQUEEGEE ASSEMBLY	SUCEUR COMPLET	SAUGFUSS KOMPLETT	LIMPIAPAVIMENTOS COMPLETO
36A	200263	1	ASSIEME TERGIPAVIMENTO	SQUEEGEE ASSEMBLY	SUCEUR COMPLET	SAUGFUSS KOMPLETT	LIMPIAPAVIMENTOS COMPLETO

GRUPPO TERGIPAVIMENTO (SPAZZANTE)  
 SQUEEGEE ASSEMBLY (T65 S)  
 ENSEMBLE DE SUCEUR (T65 S)  
 SAUGFUSSGRUPPE (T65 S)  
 GRUPO LIMPIAPAVIMENTOS (T65 S)

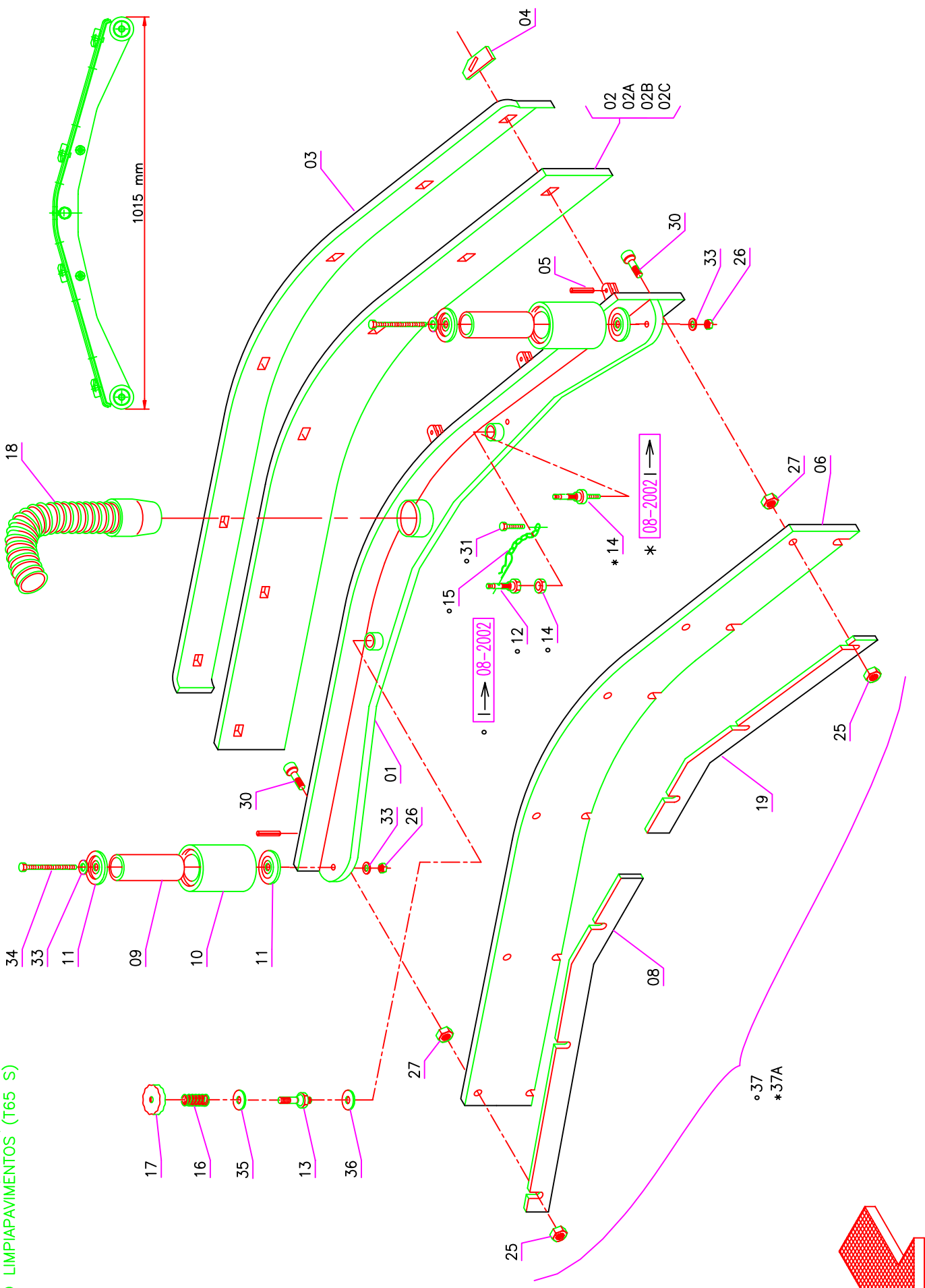

Pos. Mod.	Codice	Q.tà	Denominazione	Description	Description	Benennung	Description
01	210346	1	CORPO TERGIPAVIMENTO	SQUEEGEE BODY	CORPS DE SUCEUR	SAUGFUSSKÖRPER	CUERPO LIMPIAPAVIMENTOS
02A	406137	1	GOMMA POST. 33 SHORE	REAR RUBBER 33 SHORE	BAVETTE ARRIERE 33 SHORE	HINT. SAUGGUMMI 33 SHORE	GOMA TRASERA 33 SHORE
02B	406138	1	GOMMA POST. 40 SHORE	REAR RUBBER 40 SHORE	BAVETTE ARRIERE 40 SHORE	HINT. SAUGGUMMI 40 SHORE	GOMA TRASERA 40 SHORE
02C	406141	1	GOMMA POST. ANTIOLIO	REAR RUBBER OIL-RESISTANT	BAVETTE ARRIERE ANTI-HUILE	HINT. SAUGGUMMI OELBEST.	GOMA TRASERA ANTI-ACEITE
03	406145	1	GOMMA POST. POLIURETANO 40 SH	REAR RUBBER POLYURETHANE	BAVETTE ARR. POLYURETHANE	SAUGGUMMI POLYURETHAN	GOMA TRASERA POLIURETANO
04	203349	1	LAMA PREMIGOMMA POSTER.	BLADE	PLAQUETTE	LEISTE	LISTON
05	206390	6	PIASTRINA FISSAGGIO LAMA	PLATE	PLAQUETTE	BEFESTIGUNG	PLACA
06	201113	6	SPINA ELASTICA Ø5x14 UNI 6873	SPRING PIN	FOURCHETTE	SPANNSTIFT	PASADOR
08	203348	1	GOMMA ANTERIORE	FRONT RUBBER	BAVETTE AVANT	VORDERER SAUGGUMMI	GOMA DELANTERA
09	203353	1	LAMA PREMIGOMMA ANT. DX	RIGHT BLADE	PLAQUETTE DROITE	RECHTE LEISTE	LISTON DERECHO
10	405711	2	PERNO GUIDA RUOTA	PIN	AXE	BOLZEN	PERNO
11	203352	4	RUOTA PARACOLPI Ø 80	WHEEL	ROUE	RAD	ARANDELA ESPECIAL
12	204975	1	RONDELLA SPECIALE	SPECIAL WASHER	RONDELLE SPECIALE	UNTERLAGSCHEIBE SPEZIAL	ARANDELA ESPECIAL
13	200016	1	COLONNETTA	STUD BOLT	TIGE	GEWINDEBOLZEN	PRISIONERO
14	204367	1	DADO SPECIALE SGANCIO	STUD BOLT	TIGE	GEWINDEBOLZEN	PRISIONERO
15	203273	1	CATENELLA	SPECIAL NUT	ECROU SPECIAL	SPEZIALMUTTER	TUERCA ESPECIAL
16	408098	1	MOLLA A COMPRESSIONE	CHAIN	CHAINE	KETTE	CADENA
17	400112	1	VOLANTINO	SPRING	RESSORT	FEDER	RESORTE
18	202175	1	TUBO	HANDWHEEL	VOLANT	HANDGRIFF	RUEDA DE MANIOBRA
19	209983	1	LAMA PREMIGOMMA ANT. SN	PIPE	TUBE	ROHR	TUBO
20	200015	1	COLONNETTA	LEFT BLADE	PLAQUETTE GAUCHE	LINKE LEISTE	LISTON IZQUIERDO
25	409083	1	DADO AUT. M6 INOX UNI 7474	STUD BOLT	TIGE	GEWINDEBOLZEN	PRISIONERO
26	409090	1	DADO AUTOBL. M10 UNI 7474	LOCK NUT	ECROU AUTOBLOQUANT	STOPMUTTER	TUERCA AUTOBLOCANTE
27	409043	1	DADO M6 INOX UNI 5588	LOCK NUT	ECROU AUTOBLOQUANT	STOPMUTTER	TUERCA AUTOBLOCANTE
30	408967	1	VITE M6X20 TPSEI INOX UNI 5933	NUT	ECROU	MUTTER	TUERCA
31	408853	1	VITE M5X16 TC TC UNI 7687 INOX	SCREW	VIS	SCHRAUBE	TORNILLO
33	409191	1	RONDELLA Ø10x21 UNI 6592	SCREW	VIS	SCHRAUBE	TORNILLO
34	408736	1	VITE M10X110 TE UNI 5737	WASHER	RONDELLE	UNTERLAGSCHEIBE	ARANDELA
35	409179	1	RONDELLA Ø9x24 UNI 6593	WASHER	RONDELLE	UNTERLAGSCHEIBE	ARANDELA
36	409202	1	RONDELLA Ø12x24 UNI 6592	WASHER	RONDELLE	UNTERLAGSCHEIBE	ARANDELA
37	200262	1	ASSIEME TERGIPAVIMENTO	SQUEEGEE ASSEMBLY	SUCEUR COMPLET	SAUGFUSS KOMPLETT	LIMPIAPAVIMENTOS COMPLETO
37A	200264	1	ASSIEME TERGIPAVIMENTO	SQUEEGEE ASSEMBLY	SUCEUR COMPLET	SAUGFUSS KOMPLETT	LIMPIAPAVIMENTOS COMPLETO

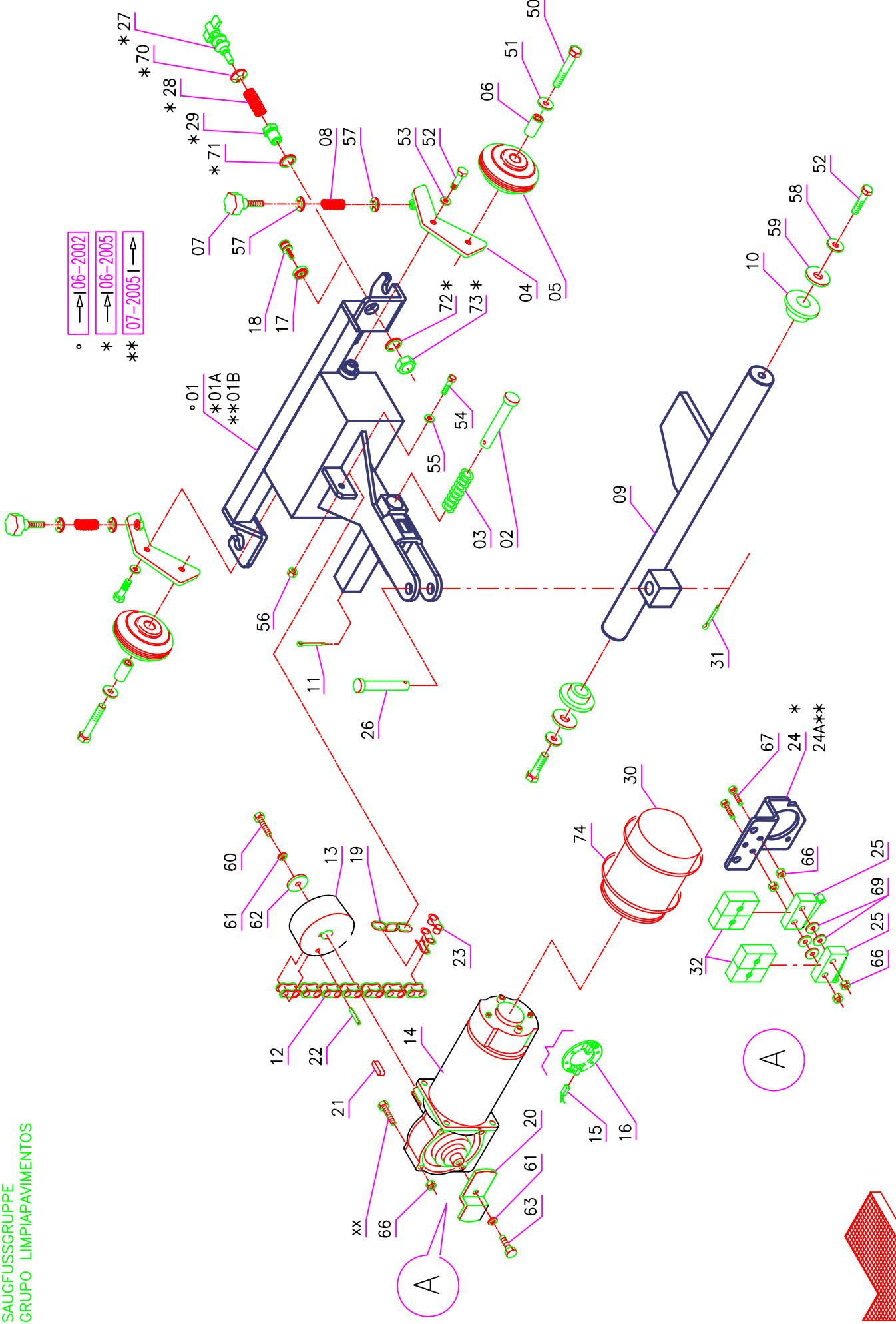



Pos.	Mod.	Codice	Q.tà	Denominazione	Description	Description	Benennung	Description
01		206656	1	BRACCIO TERGIPAVIMENTO	ARM	BRAS	ARM	BRAZO
01A		206658	1	BRACCIO TERGIPAVIMENTO	ARM	BRAS	ARM	BRAZO
01B		206658	1	BRACCIO TERGIPAVIMENTO	ARM	BRAS	ARM	BRAZO
02		400768	1	PULSANTE FINECORSA	PUSH BUTTON	BOUCHON POUSSOIR	DRUCKKNOPF	PULSADOR
03		408100	1	MOLLA COMPRESSIONE	SPRING	RESSORT	FEDER	RESORTE
04		400375	2	STAFFA RUOTINA	SUPPORT	ATTAQUE	HALTERUNG	SOPORTE FIJADOR
05		405684	2	RUOTA Ø80x35	WHEEL	ROUE	RAD	RUEDA
06		408035	2	BOCCOLA	BUSHING	BAGUE	BUGHE	CASQUILLO
07		410241	2	POMELLO	KNOB	POMMEAU	RENDELSCHRAUBE	POMO
08		408097	2	MOLLA A COMPRESSIONE	SPRING	RESSORT	FEDER	RESORTE
09		206655	1	ALBERO COMANDO TERGIP.	SHAFT	ARBRE	WELLE	EJE
10		408039	2	BOCCOLA	BUSHING	BAGUE	BUGHE	CASQUILLO
11		409389	1	COPIGLIA Ø2.5x25 UNI 1336	SPLIT PIN	GOUPILLE	SPLINT	PASADOR DE ALETAS
12		408385	1	CATENA	CHAIN	CHAINE	KETTE	CADENA
13		400613	1	RULLO	ROLLER	GALET	ROLLE	RODILLO
14		407755	1	MOTORIDUTTORE	GEARED MOTOR	MOTO-REDUCTEUR	GETRIEBEMOTOR	MOTORREDUCTOR
15		409400	2	SPAZZOLA MOTORE	CARBON BRUSH MOTOR	CHARBON MOTEUR	KOHLEBÜRSTE	ESCOBILLA MOTOR
16		409738	1	ANELLO PORTASPAZZOLE	CARBON BRUSH HOLDER	PORTE-CHARBON	KOHLEBÜRSTENHALTERUNG	PORTACEPILOS
17		400113	1	VOLANTINO Ø40x9 M10	HANDWHEEL	VOLANT	HANDGRIFF	RUEDA DE MANIOBRA
18		400267	1	REGISTRO INCLINAZIONE	ADJUSTER	REGLAGE	VERSTELLSCHRAUBE	REGULADOR
19		206652	1	CATENA N.3 ANELLI	CHAIN	CHAINE	KETTE	CADENA
20		203576	1	LEVA	LEVER	LEVIER	HEBEL	PALANCA
21		408402	1	CHIAVETTA 5x5x20 UNI 6604/69	KEY	CLAVETTE	KEIL	CLAVIJA
22		409368	1	SPINA Ø4x36 UNI 6873	SPRING PIN	FOURCHETTE	SPANNSTIFT	PASADOR
23		408380	1	GIUNTO CATENA	JOINT CHAIN	ATTACHE RAPID CHAINE	KETTENSCHLOSS	ESLABON
24		203625	1	STAFFA MICRO	SUPPORT	ATTAQUE	HALTERUNG	SOPORTE FIJADOR
24A		400769	1	STAFFA MICRO	SUPPORT	ATTAQUE	HALTERUNG	SOPORTE FIJADOR
25		409493	2	MICROINTERRUTTORE	MICROSWITCH	MICRO-INTERRUPTEUR	MIKROSCHALTER	MICROINTERRUPTOR
26		203624	1	PERNO	PIN	AXE	BOLZEN	PERNO
27		205422	1	REGISTRO INCLINAZIONE	ADJUSTER	REGLAGE	VERSTELLSCHRAUBE	REGULADOR
28		408103	1	MOLLA A COMPRESSIONE	SPRING	RESSORT	FEDER	RESORTE
29		400377	1	BOCCOLA M10	BUSHING	BAGUE	BUGHE	CASQUILLO
30		405938	1	CUFFIA MOTORE	SHROUD	JOINT	LAGERRING	ANILLO
31		409390	1	COPIGLIA Ø2.5x30 UNI 1336	SPLIT PIN	GOUPILLE	SPLINT	PASADOR DE ALETAS
32		400631	2	PROTEZIONE MICROINTERRUTTORE	PROTECTION	PROTECTION	ABDECKUNG	PROTECCION
50		408730		VITE M10x60 TE UNI 5737	SCREW	VIS	SCHRAUBE	TORNILLO
51		409191		RONDELLA Ø10x21 UNI 6592	WASHER	RONDELLE	UNTERLAGSCHEIBE	ARANDELA
52		408669		VITE M8x16 TE UNI 5739	SCREW	VIS	SCHRAUBE	TORNILLO
53		409175		RONDELLA Ø8x17 UNI 6592	WASHER	RONDELLE	UNTERLAGSCHEIBE	ARANDELA
54		407667		VITE M6x20 TE UNI 5739 INOX	SCREW	VIS	SCHRAUBE	TORNILLO
55		409161		RONDELLA Ø 6x18 INOX UNI 6593	WASHER	RONDELLE	UNTERLAGSCHEIBE	ARANDELA
56		409083		DADO AUT. M6 INOX UNI 7474	LOCK NUT	ECROU AUTOBLOQUANT	STOPMUTTER	TUERCA AUTOBLOCANTE
57		409340		RONDELLA DENTELLATA Ø8	LOCK WASHER	RONDELLE FREIN	ZAHNSCHEIBE	ARANDELA DENTADA
58		409181		RONDELLA Ø8 GROWER	WASHER	RONDELLE	UNTERLAGSCHEIBE	ARANDELA
59		409180		RONDELLA Ø 9x32 UNI 6593	WASHER	RONDELLE	UNTERLAGSCHEIBE	ARANDELA
60		407666		VITE M6x20 TE UNI 5739	SCREW	VIS	SCHRAUBE	TORNILLO
61		409164		RONDELLA GROWER Ø6	LOCK WASHER	RONDELLE FREIN	ZAHNSCHEIBE	ARANDELA DENTADA
62		409170		RONDELLA D.6x24 INOX UNI 6593	WASHER	RONDELLE	UNTERLAGSCHEIBE	ARANDELA
63		407663		VITE M6x16 TE UNI 5739	SCREW	VIS	SCHRAUBE	TORNILLO
64		409156		RONDELLA Ø6x12 UNI 6592	WASHER	RONDELLE	UNTERLAGSCHEIBE	ARANDELA
65		409082		DADO M6 AUTOBL. UNI 7474	LOCK NUT	ECROU AUTOBLOQUANT	STOPMUTTER	TUERCA AUTOBLOCANTE
66		409036		DADO M5 UNI 5587	NUT	ECROU	MUTTER	TUERCA
67		407649		VITE M5X40 TE UNI 5739	SCREW	VIS	SCHRAUBE	TORNILLO
68		409080		DADO AUTOBL. M5 UNI 7473	LOCK NUT	ECROU AUTOBLOQUANT	STOPMUTTER	TUERCA AUTOBLOCANTE
69		409150		RONDELLA Ø5x11 UNI 6592	WASHER	RONDELLE	UNTERLAGSCHEIBE	ARANDELA
70		409349		RONDELLA Ø13x18 SCHNORR	WASHER	RONDELLE	UNTERLAGSCHEIBE	ARANDELA
71		210514		RONDELLA Ø16.5x24.5 UNI 6592	WASHER	RONDELLE	UNTERLAGSCHEIBE	ARANDELA
72		409352		RONDELLA Ø17x24 SCHNORR	WASHER	RONDELLE	UNTERLAGSCHEIBE	ARANDELA

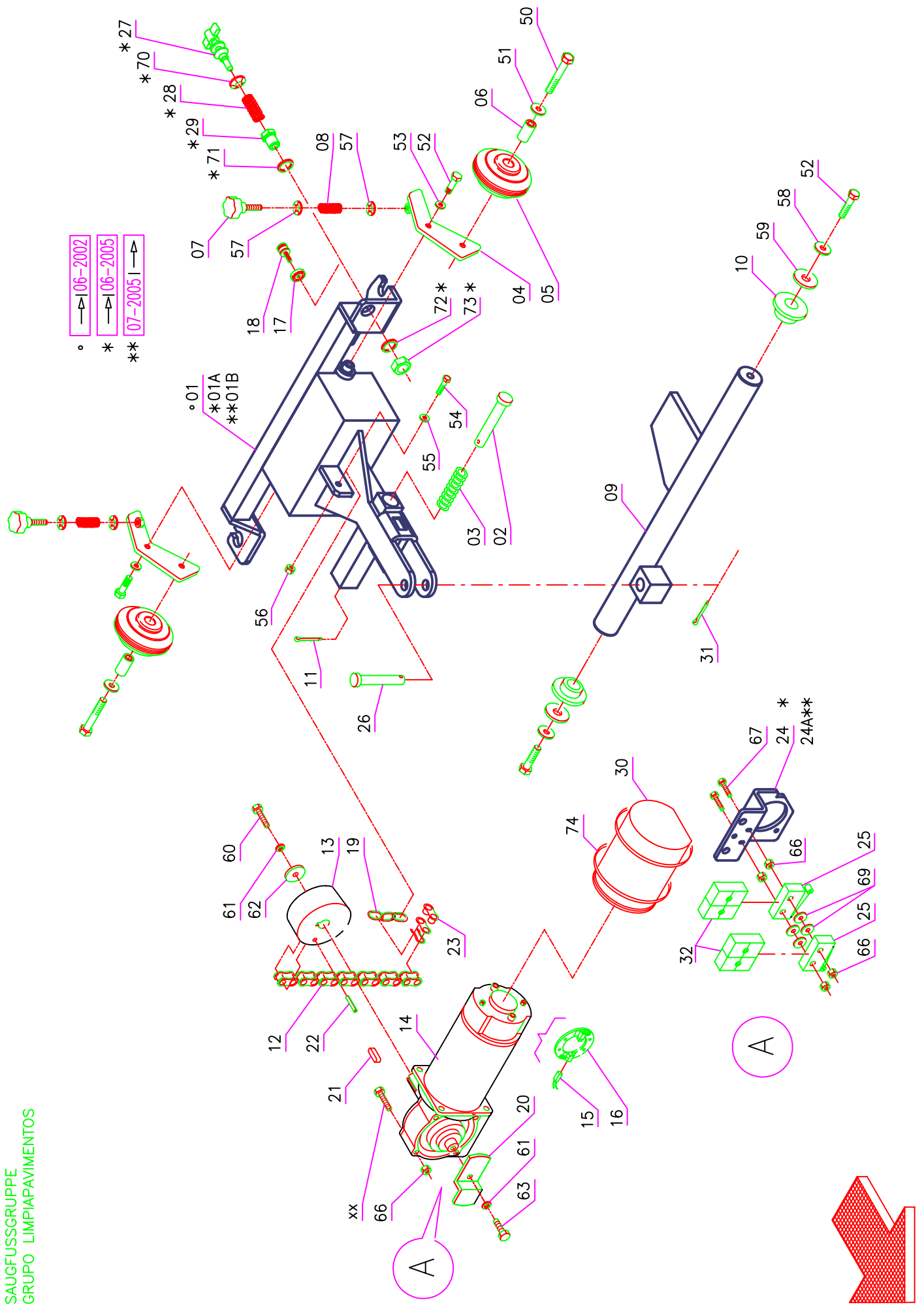

Pos.	Mod.	Codice	Q.tà	Denominazione	Description	Benennung	Description
73		409074		DADO M16X1.5X8 UNI 5589	NUT	MUTTER	TUERCA
74		410276		FASCETTA 4.8X360	CLAMP	BRIDE	ABRAZADERA

GRUPPO TELAIO CARROZZERIA  
ASSEMBLY FRAME-BODYWORK  
GROUPE DE CHASSIS-CARROSSERIE  
GRUPPE FAHRGESTELL-KAROSSERIE  
GRUPO BASTIDOR-CARROCERIA

→ 05004778

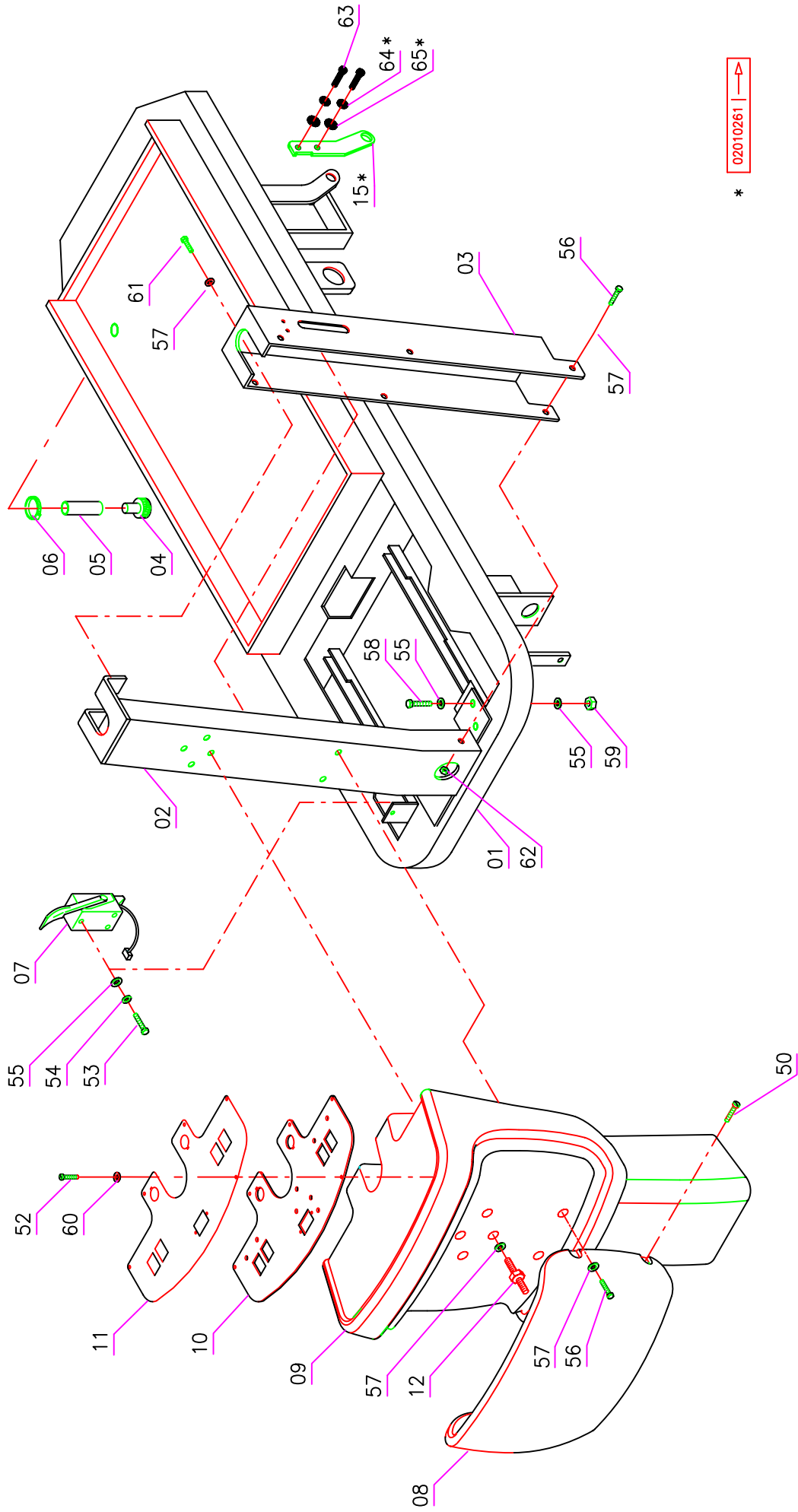

02010261 →

\*



Pos. Mod.	Codice	Q.tà	Denominazione	Description	Description	Benennung	Description
01	209909	1	TELAIO	FRAME	CHASSIS	RAHMEN	BASTIDOR
02	407633	1	TELAIO	FRAME	CHASSIS	RAHMEN	BASTIDOR
03	206752	1	CARTER ALBERO SUP.	COVER	CARTER	ABDECKUNG	CARTER
04	400651	1	TAPPO	CAP	CAPUCHON	KAPPE	TAPON
05	209551	1	TUBO POLAR	PIPE	TUBE	ROHR	TUBO
06	410297	1	FASCETTA A VITE	CLAMP	COLLIER	BRIDE	ABRAZADERA
07	410479	1	PEDALE	PEDAL	PEDALE	PEDAL	PEDAL
08	400792	1	CARTER MUSETTO	COVER	CARTER	ABDECKUNG	CARTER
09	400791	1	RIVESTIMENTO ANTERIORE	COVER	CARTER	ABDECKUNG	CARTER
10	206755	1	LAMIERA CRUSCOTTO	PLATE	TOLE	PLATTE	CHAPA
11	405006	1	ETICHETTA CRUSCOTTO	DECAL	ETIQUETTE	SCHILD	ETIQUETA
12	206766	1	COLONNETTA FISS. PANN.	STUD BOLT	TIGE	GEWINDEBOLZEN	PRISIONERO
15	203626	2	ATTACCO SX ALBERO TERGI	COUPLING	ATTAQUE	KUPPLUNG	ACOPPLAMENTO
50	408517	1	VITE M5x35 TSC UNI 7689 INOX	SCREW	VIS	SCHRAUBE	TORNILLO
52	408870	1	VITE Ø3.9X10 UNI 6954 AUTOF.	SCREW	VIS	SCHRAUBE	TORNILLO
53	408669	1	VITE M8x16 TE UNI 5739	SCREW	VIS	SCHRAUBE	TORNILLO
54	409181	1	RONDELLA Ø8 GROWER	WASHER	RONDELLE	UNTERLAGSCHEIBE	ARANDELA
55	409175	1	RONDELLA Ø8x17 UNI 6592	WASHER	RONDELLE	UNTERLAGSCHEIBE	ARANDELA
56	407666	1	VITE M6x20 TE UNI 5739	SCREW	VIS	SCHRAUBE	TORNILLO
57	409162	1	RONDELLA Ø6x24 UNI 6593	WASHER	RONDELLE	UNTERLAGSCHEIBE	ARANDELA
58	408674	1	VITE M8x25 TE UNI 5739	SCREW	VIS	SCHRAUBE	TORNILLO
59	409085	1	DADO AUTOBL. M8 UNI 7474	LOCK NUT	ECROU AUTOBLOQUANT	STOPMUTTER	TUERCA AUTOBLOCCANTE
60	409147	1	RONDELLA Ø4X10 NYLON	WASHER	RONDELLE	UNTERLAGSCHEIBE	ARANDELA
61	408861	1	VITE M6X25 TCTC UNI 7687	SCREW	VIS	SCHRAUBE	TORNILLO
62	409082	1	DADO M6 AUTOBL. UNI 7474	LOCK NUT	ECROU AUTOBLOQUANT	STOPMUTTER	TUERCA AUTOBLOCCANTE
63	408718	1	VITE M10x70 TE UNI 5739	SCREW	VIS	SCHRAUBE	TORNILLO
64	409196	1	RONDELLA Ø10 GROWER	WASHER	RONDELLE	UNTERLAGSCHEIBE	ARANDELA
65	409191	1	RONDELLA Ø10x21 UNI 6592	WASHER	RONDELLE	UNTERLAGSCHEIBE	ARANDELA

GRUPPO TELAIO CARROZZERIA  
ASSEMBLY FRAME-BODYWORK  
GROUPE DE CHASSIS-CARROSSERIE  
GRUPPE FAHRGESTELL-KAROSSERIE  
GRUPO BASTIDOR-CARROCERIA

050004779 | →

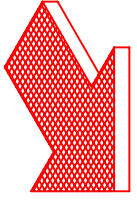
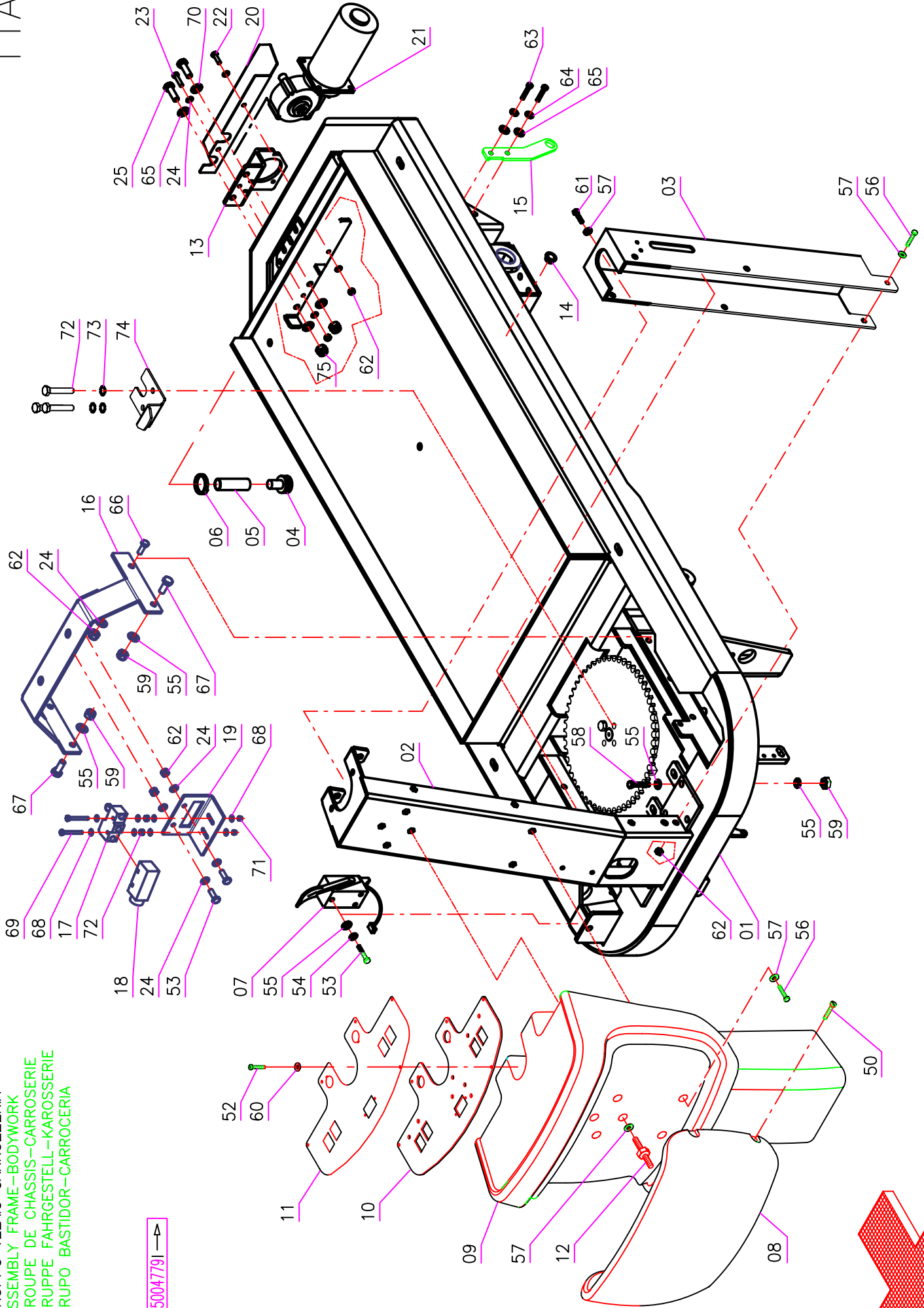

Pos. Mod.	Codice	Q.tà	Denominazione	Description	Description	Benennung	Description
01	209909	1	TELAIO	FRAME	CHASSIS	RAHMEN	BASTIDOR
02	407633	1	TELAIO	FRAME	CHASSIS	RAHMEN	BASTIDOR
03	206752	1	CARTER ALBERO SUP.	COVER	CARTER	ABDECKUNG	CARTER
04	400651	1	TAPPO	CAP	CAPUCHON	KAPPE	TAPON
05	209551	1	TUBO POLAR	PIPE	TUBE	ROHR	TUBO
06	410297	1	FASCETTA A VITE	CLAMP	COLLIER	BRIDE	ABRAZADERA
07	410479	1	PEDALE	PEDAL	PEDALE	PEDAL	PEDAL
08	400792	1	CARTER MUSETTO	COVER	CARTER	ABDECKUNG	CARTER
09	400791	1	RIVESTIMENTO ANTERIORE	COVER	CARTER	ABDECKUNG	CARTER
10	206755	1	LAMIERA CRUSCOTTO	PLATE	TOLE	PLATTE	CHAPA
11	405006	1	ETICHETTA CRUSCOTTO	DECAL	ETIQUETTE	ETIQUETA	ETIQUETA
12	206766	2	COLONNETTA FISS. PANN.	STUD BOLT	TIGE	GEWINDEBOLZEN	PRISIONERO
13	400769	1	STAFFA SUPPORTO MOTORID.	SUPPORT	ATTAQUE	HALTERUNG	SOPORTE FIJADOR
14	408040	1	BOCCOLA	BUSHING	BAGUE	BUCHSE	CASQUILLO
15	203626	1	ATTACCO SX ALBERO TERGI	COUPLING	ATTAQUE	KUPPLUNG	ACOPLAMIENTO
16	206674	1	SUPPORTO	SUPPORT	SUPPORT	HALTERUNG	SOPORTE
17	409493	1	MICROINTERRUTTORE	MICROSWITCH	MICROINTERRUPTEUR	MIKROSCHALTER	MICROINTERRUPTOR
18	400631	1	PROTEZIONE MICROINT.	PROTECTION	PROTECTION	ABDECKUNG	PROTECCION
19	206675	1	LAMA ATTACCO MICROINT.	BLADE	PLAQUE	PLATTE	LISTON
20	400770	1	CARTER PROTEZIONE MOTORID.	COVER	CARTER	ABDECKUNG	CARTER
21	407755	1	MOTORID. 36V 60W	GEARED MOTOR	MOTO-REDUCTEUR	GETRIEBEMOTOR	MOTORREDUCTOR
22	407666		VITE M6X20 TE UNI 5739	SCREW	VIS	SCHRAUBE	TORNILLO
23	407669		VITE M6X25 TE UNI 5739	SCREW	VIS	SCHRAUBE	TORNILLO
24	409156		RONDELLA Ø6X12 UNI 6592	WASHER	RONDELLE	SCHRAUBE	AFANDELA
25	408712		VITE M10X30 TE UNI 5739	SCREW	VIS	SCHRAUBE	TORNILLO
50	408517		VITE M5x35 TSC UNI 7689 INOX	SCREW	VIS	SCHRAUBE	TORNILLO
52	408870		VITE Ø3.9X10 UNI 6954 AUTOF.	SCREW	VIS	SCHRAUBE	TORNILLO
53	408669		VITE M8X16 TE UNI 5739	SCREW	VIS	SCHRAUBE	TORNILLO
54	409181		RONDELLA Ø8 GROWER	WASHER	RONDELLE	SCHRAUBE	AFANDELA
55	409175		RONDELLA Ø8x17 UNI 6592	WASHER	RONDELLE	SCHRAUBE	AFANDELA
56	407666		VITE M6x20 TE UNI 5739	SCREW	VIS	SCHRAUBE	TORNILLO
57	409162		RONDELLA Ø6x24 UNI 6593	WASHER	RONDELLE	SCHRAUBE	AFANDELA
58	408674		VITE M8x25 TE UNI 5739	SCREW	VIS	SCHRAUBE	TORNILLO
59	409085		DADO AUTOBL. M8 UNI 7474	LOCK NUT	ECROU AUTOBLOQUANT	STOPMUTTER	TUERCA AUTOBLOCANTE
60	409147		RONDELLA Ø4X10 NYLON	WASHER	RONDELLE	UNTERLAGSCHEIBE	AFANDELA
61	408861		VITE M6X25 TCTC UNI 7687	SCREW	VIS	SCHRAUBE	TORNILLO
62	409082		DADO M6 AUTOBL. UNI 7474	LOCK NUT	ECROU AUTOBLOQUANT	STOPMUTTER	TUERCA AUTOBLOCANTE
63	408718		VITE M10x70 TE UNI 5739	SCREW	VIS	SCHRAUBE	TORNILLO
64	409196		RONDELLA Ø10 GROWER	WASHER	RONDELLE	UNTERLAGSCHEIBE	AFANDELA
65	409191		RONDELLA Ø10x21 UNI 6592	WASHER	RONDELLE	UNTERLAGSCHEIBE	AFANDELA
66	407665		VITE M6X18 TE UNI 5739	SCREW	VIS	SCHRAUBE	TORNILLO
67	408670		VITE M8X20 TE UNI 5739	SCREW	VIS	SCHRAUBE	TORNILLO
68	409142		RONDELLA M4 UNI 6592	WASHER	RONDELLE	SCHRAUBE	AFANDELA
69	408637		VITE M4X35 TE UNI 5739 INOX	SCREW	VIS	SCHRAUBE	TORNILLO
70	409078		DADO M4X6 AUTOBL. UNI 7473	LOCK NUT	ECROU AUTOBLOQUANT	STOPMUTTER	TUERCA AUTOBLOCANTE
71	409034		DADO M4X4 UNI 5587	NUT	EGROU	MUTTER	TUERCA
72	408681		VITE M8X45 TE UNI 5739	SCREW	VIS	SCHRAUBE	TORNILLO
73	409340		ROSETTA M8 DIN 6798/A	WASHER	RONDELLE	UNTERLAGSCHEIBE	AFANDELA
74	206726		CAMMA	CAM WHEEL	CAME	NOCKEN	LEVA

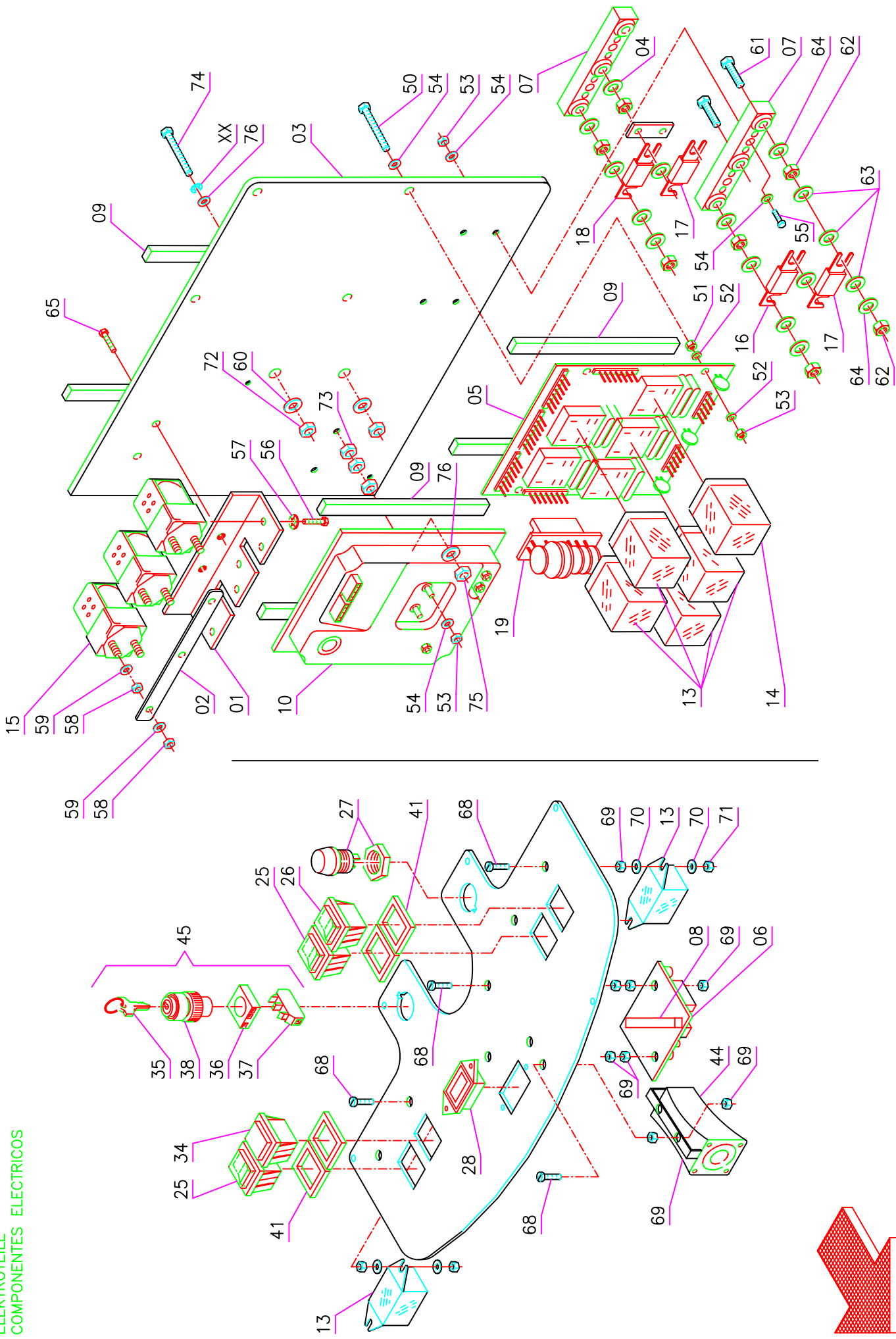



Pos. Mod.	Codice	Q.tà	Denominazione	Description	Description	Benennung	Description
01	203405	1	STAFFA TELERUTORI	SUPPORT	ATTAQUE	HALTERUNG	SOPORTE FIJADOR
02	400433	1	PONTE TELERUTORI	BRIDGE	PONTAGE	VERBINDUNGSBRÜCKE	PUENTE
03	206765	1	PANNELLO IMPIANTO ELET.	PANEL	PANNEAU	BLECH	PANEELE
04	400808	1	PONTE FUSIBILE	BRIDGE	PONTAGE	VERBINDUNGSBRÜCKE	PUENTE
05	406265	1	SCHEDA CONTR. COMANDI	CHECK CARD CONTROLS	PLAQUE CONTR. COMMANDES	KONTROLLEL. SCHALTUNGEN	FICHA CONTROL MANDOS
06	406367	1	SCHEDA CONTROLLO BATTERIE	CHECK CARD BATTERIES	PLAQUE CONTROLE BATTERIES	KONTROLLEL. BATTERIEN	FICHA CONTROL BATTERIAS
07	409584	2	PORTAFUSIBILE DOPPIO	FUSEHOLDER	PORTE-FUSIBLE	SICHERUNGSHALTER	PORTAFUSIBLE
08	209458	1	GUARNIZIONE 10X10X60	GASKET	JOINT	DICHTUNG	JUNTA
09	209461	6	GUARNIZIONE 10X10X140	GASKET	JOINT	DICHTUNG	JUNTA
10	406364	1	SCHEDA CHOPPER	CHOPPER CARD	VARIATEUR ELECTRONIQUE	ELEKTRONIKKARTE	FICHA CHOPPER
13	407581	6	RELÈ	RELAY	RELAIS	RELAIS	RELE
14	407580	1	RELÈ	RELAY	RELAIS	RELAIS	RELE
15	407587	3	TELERUTTORE 38V	REMOTE CONTROL SWITCH	TELERUPTEUR	SCHÜTZ	TELERRUPTOR
16	409608	1	FUSIBILE 35A	FUSE	FUSIBLE	SICHERUNG	FUSIBLE
17	409616	2	FUSIBILE PROTETTO 80A	FUSE	FUSIBLE	SICHERUNG	FUSIBLE
18	409620	1	FUSIBILE 160A	FUSE	FUSIBLE	SICHERUNG	FUSIBLE
19	406266	1	SCHEDA FUSIBILI	CHECK CARD FUSES	PLAQUE CONTROLE FUSIBLES	KONTROLLKARTE SICHERUNGEN	FICHA CONTROL FUSIBLES
25	415992	2	DEVIATORE	SWITCH	INTERRUPTEUR	SCHALTER	DESVIADOR
26	409476	1	DEVIATORE MOMENTANEO	SWITCH	INTERRUPTEUR	SCHALTER	DESVIADOR
27	409782	1	PULSANTE	PUSH BUTTON	BOUTON POUSSOIR	DRUCKKNOPF	PULSADOR
28	409772	1	CONTAORE	HOUR METER	COMPTEUR HORAIRE	BETRIEBSSTUNDENZÄHLER	CUENTAHORAS
34	409546	1	SEGNALE BATTERIE	BATTERY WARNING LIGHT	TEMOIN DE BATTERIES	BATTERIESIGNAL	SEÑAL BATTERIAS
35	409297	1	CHIAVE	KEY	CLEF	SCHLÜSSEL	LLAVE
36	409262	1	FLANGIA PER CONTATTO	FLANGE	FLASQUE	FLANSCH	BRIDA
37	409246	1	CONTATTO	CONTACT	CONTACT	KONTAKT	CONTACTO
38	409261	1	INTERRUTTORE A CHIAVE	SWITCH WITH KEY	INTERRUPTEUR A CLEF	SCHLÜSSELSCHALTER	INTERRUPTOR CON LLAVE
41	405915	4	GUARNIZIONE	GASKET	JOINT	DICHTUNG	JUNTA
44	409789	1	CLACSON	HORN	KLAXON	HUPE	BOCINA
50	408634	1	VITE M4x20 TE UNI 5739	SCREW	VIS	SCHRAUBE	TORNILLO
51	409034	1	DADO M4 UNI 5587	NUT	ECROU	MUTTER	TUERCA
52	409145	53	RONDELLA Ø4x12 POLIETILENE	WASHER	RONDELLE	UNTERLAGSCHEIBE	ARANDELA
53	409078	52	DADO AUTOBL. M4 UNI 7473	LOCK NUT	ECROU AUTOBLOQUANT	STOPMUTTER	TUERCA AUTOBLOCANTE
54	409142	54	RONDELLA Ø4x9 UNI 6592	WASHER	RONDELLE	UNTERLAGSCHEIBE	ARANDELA
55	408772	55	VITE M4X20 TC UNI 6107 INOX	SCREW	VIS	SCHRAUBE	TORNILLO
56	408767	56	VITE M4x6 TC INOX UNI 6107	SCREW	VIS	SCHRAUBE	TORNILLO
57	409333	57	RONDELLA Ø4 DENT.	LOCK WASHER	RONDELLE FREIN	ZAHNSCHEIBE	ARANDELA DENTADA
58	409050	58	DADO M8 OTTONE UNI 5588	NUT BRASS	ECROU LAITON	MUTTER MESSING	TUERCA LATON
59	409181	59	RONDELLA Ø8 GROWER	WASHER	RONDELLE	UNTERLAGSCHEIBE	ARANDELA
60	409175	60	RONDELLA Ø8x17 UNI 6592	WASHER	RONDELLE	UNTERLAGSCHEIBE	ARANDELA
61	408678	61	VITE M8x35 TE UNI 5739	SCREW	VIS	SCHRAUBE	TORNILLO
62	409046	62	DADO M8 UNI 5588	NUT	ECROU	MUTTER	TUERCA
63	409176	63	RONDELLA Ø8x17 OTTONE	WASHER	RONDELLE	UNTERLAGSCHEIBE	ARANDELA
64	409181	64	RONDELLA Ø8 GROWER	WASHER	RONDELLE	UNTERLAGSCHEIBE	ARANDELA
65	407661	65	VITE M6x14 TE UNI 5739	SCREW	VIS	SCHRAUBE	TORNILLO
68	408923	68	VITE M3X16 TPS UNI 6109 INOX	SCREW	VIS	SCHRAUBE	TORNILLO
69	409032	69	DADO M3 UNI 5587 INOX	NUT	ECROU	MUTTER	TUERCA
70	409139	70	RONDELLA Ø3x8 UNI 6593	WASHER	RONDELLE	UNTERLAGSCHEIBE	ARANDELA
71	409077	71	DADO AUTOBL. M3 UNI 7473	LOCK NUT	ECROU AUTOBLOQUANT	STOPMUTTER	TUERCA AUTOBLOCANTE
72	409085	72	DADO AUTOBL. M8 UNI 7474	LOCK NUT	ECROU AUTOBLOQUANT	STOPMUTTER	TUERCA AUTOBLOCANTE
73	409036	73	DADO M5 UNI 5587	NUT	ECROU	MUTTER	TUERCA
74	408852	74	VITE M5x30 TCTC UNI 7687	SCREW	VIS	SCHRAUBE	TORNILLO
75	409080	75	DADO AUTOBL. M5 UNI 7473	LOCK NUT	ECROU AUTOBLOQUANT	STOPMUTTER	TUERCA AUTOBLOCANTE
76	409151	76	RONDELLA Ø5x15 UNI 6593	WASHER	RONDELLE	UNTERLAGSCHEIBE	ARANDELA

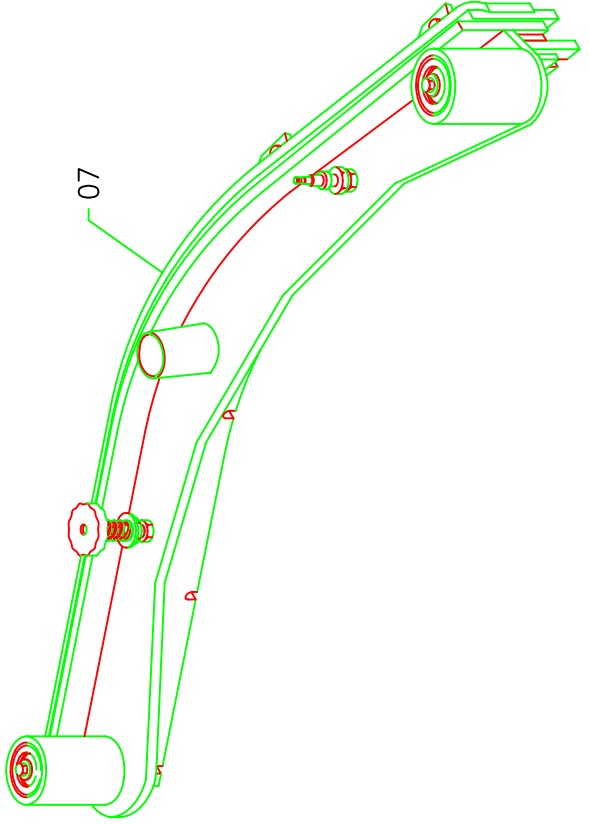
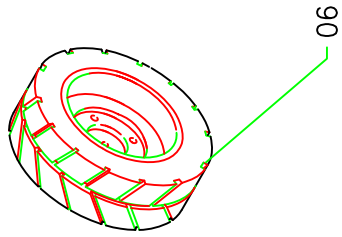
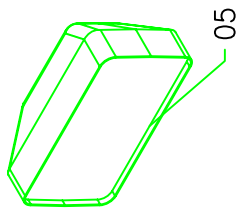
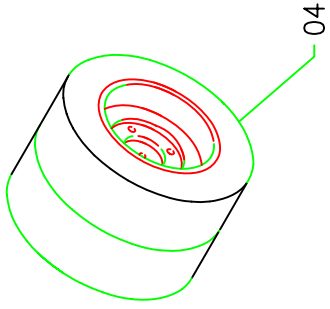
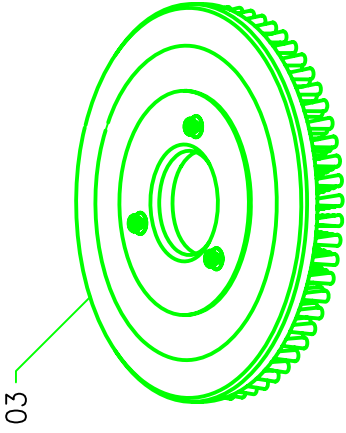
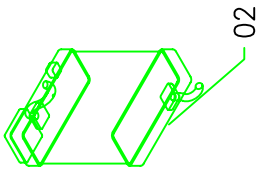
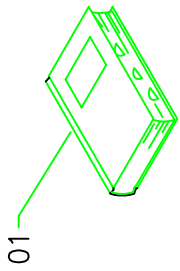

Pos	Mod	Codice	Q.tà	Denominazione	Description	Description	Benennung	Description
01		410725	1	CAT. USO E MANUTENZIONE	USE AND MAINTENANCE	EMPLOI ET ENTRETIEN	BEDIENUNG UND WARTUNGSA	USO Y MANTENIMIENTO
02		410930	1	CARICABATTERIE 230V/50hz/36V/30A	BATTERY RECHARGER	CHARGEUR DE BATTERIES	LADEGERAET	CARGADOR DE BATERIAS
02A		410939	1	CARICABAT. GEL 230V/50hz/36V/40A	BATTERY RECHARGER	CHARGEUR DE BATTERIES	LADEGERAET	CARGADOR DE BATERIAS
03		405592	2	SPAZZOLA PPL-0.9-	BRUSH	BROSSE	BUERSTE	CEPILLO
03A		405591	2	SPAZZOLA PPL-0.6-	BRUSH	BROSSE	BUERSTE	CEPILLO
03B		405590	2	SPAZZOLA PPL-0.3-	BRUSH	BROSSE	BUERSTE	CEPILLO
03C		405593	2	SPAZZOLA ABRASIVA 1,5	BRUSH	BROSSE	BUERSTE	CEPILLO
03D		405594	2	SPAZZOLA ACCIAIO 0.3	BRUSH	BROSSE	BUERSTE	CEPILLO
03E		405512	2	DISCO TRASCINATORE	PAD HOLDER	PLATEAU	TREIBTELLER	DISCO DE ARRASTRE
03F		405521	2	DISCO TRASC. C.C LOCK	PAD HOLDER	PLATEAU	TREIBTELLER	DISCO DE ARRASTRE
03G		405598	2	SPAZZ. CILINDRICA PPL-1-	BRUSH	BROSSE	BUERSTE	CEPILLO
03H		405599	2	SPAZZ. CILINDRICA PPL-0.8-	BRUSH	BROSSE	BUERSTE	CEPILLO
03I		405560	2	SPAZZ. CILINDRICA ABRASIVA 1	BRUSH	BROSSE	BUERSTE	CEPILLO
04		200142	1	KIT RUOTE GEMELLATE ANTERIORI	FORE TWIN WHEELS KIT	KIT ROUE AVANT JUMEAU	KIT VORDERER PAARIG RADER	KIT GEMELO RUEDA DELANT.
04A		200143	1	KIT RUOTE GEMELLATE POSTERIORI	REAR TWIN WHEELS KIT	KIT ROUE ARRIERE JUMEAU	KIT HINT. PAARIG RADER	KIT GEMELO RUEDA TRASERA
05		200150	1	KIT FARI	LIGHTS KIT	KIT PHARE	KIT LEUCHTEN	KIT LUCES
06		405727	2	RUOTE POSTERIORI ANTITRACCIA	REAR RUBBER WHEELS	ROUE CAOUTCHOUC ARR.	HINT. GUMMIRAD	RUEDA TRASERA DE GOMA
07		200263	1	TERGIPAVIMENTO COMPLETO LAV.	SQUEEGEE ASSEMBLY	SUCEUR COMPLETE	SAUGFUSS KOMPLETT	LIMPI/APAVIMENTOS COMPL.
07A		200264	1	TERGIPAVIMENTO COMPLETO SPAZ.	SQUEEGEE ASSEMBLY	SUCEUR COMPLETE	SAUGFUSS KOMPLETT	LIMPI/APAVIMENTOS COMPL.
07B		200267	1	TERGIPAVIMENTO COMPLETO L1112	SQUEEGEE ASSEMBLY	SUCEUR COMPLETE	SAUGFUSS KOMPLETT	LIMPI/APAVIMENTOS COMPL.



---

Le descrizioni contenute nella presente pubblicazione non si intendono impegnative. La Ditta pertanto, si riserva il diritto di apportare in qualunque momento, le eventuali modifiche ad organi, dettagli, forniture di accessori, che essa ritiene convenienti per un miglioramento o per qualsiasi esigenza di carattere costruttivo o commerciale.

La riproduzione anche parziale dei testi e dei disegni, contenuti nel presente catalogo, è vietata ai sensi di legge.

---

The descriptions and illustrations contained in the present publication are understood to be non-binding. The Manufacturer thus reserves the rights to effect, at any time any such alterations to items, component parts and accessory supplies as it may deem necessary for the purposes of improvement or in order to meet any demand of constructional or commercial nature.

Reproduction of either text or drawings, in full or in part, other than with the prior written consent of Comac, is expressly forbidden.

---

Les descriptions et les illustrations contenues dans la présente publication n'engagent pas le constructeur. Le Fabriquant se réserve le droit de modifier à tout moment les organes, détails et fournitures d'accessoires nécessaires à une amélioration technique ou commerciale des machines.

La reproduction même partielle des textes et illustrations contenus dans ce catalogue est illégale, tout contrairement elle pourra être pénalement poursuivie.

---

Die in dieser Anleitung enthaltenen Beschreibungen und Abbildungen sind unverbindlich. Die Firma behält sich das Recht vor, eventuelle Änderungen an Elementen, Einzelteilen und Lieferungen von Zubehörteilen ohne Ankündigung vorzunehmen, welche sich im Hinblick auf konstruktive Verbesserungen ergeben.

Der Nachdruck der Texte und Zeichnungen, die in diesem Katalog enthalten sind, auch teilweise, ist laut Gesetz untersagt.

---

Las descripciones contenidas en esa publicación no son vinculantes. Por consiguiente la Empresa se reserva el derecho de modificar eventualmente en cualquier momento las piezas, los detalles y los suministros de piezas de repuesto, de la manera que considera útil para lograr mejoras o por cualquier exigencia de tipo constructivo o comercial.

La reproducción aún parcial de los textos y de los dibujos contenidos en este catálogo queda prohibida con arreglo a la ley.

---